

ROCKWALL CITY COUNCIL REGULAR MEETING

Monday, October 2, 2023 - 5:00 PM

City Hall Council Chambers - 385 S. Goliad St., Rockwall, TX 75087

I. Call Public Meeting to Order

II. Executive Session

The City of Rockwall City Council will recess into executive session to discuss the following matter as authorized by chapter 551 of the Texas government code:

1. Discussion regarding (re)appointments to city regulatory boards and commissions, pursuant to §551.074 (Personnel Matters).

III. Adjourn Executive Session

IV. Reconvene Public Meeting (6:00 P.M.)

V. Invocation and Pledge of Allegiance - Councilmember Thomas

VI. Proclamations / Awards / Recognitions

1. Domestic Violence Awareness Month
2. National Night Out
3. Fire Prevention Month

VII. Open Forum

This is a time for anyone to address the Council and public on any topic not already listed on the agenda or set for a public hearing. To speak during this time, please turn in a (yellow) "Request to Address City Council" form to the City Secretary either before the meeting or as you approach the podium. Per Council policy, public comments should be limited to three (3) minutes out of respect for others' time. On topics raised during Open Forum, please know Council is not permitted to respond to your comments during the meeting since the topic has not been specifically listed on the agenda (the Texas Open Meetings Act requires that topics of discussion/deliberation be posted on an agenda not less than 72 hours in advance of the Council meeting). This, in part, is so that other citizens who may have the same concern may also be involved in the discussion.

VIII. Take Any Action as a Result of Executive Session

IX. Consent Agenda

These agenda items are routine/administrative in nature, have previously been discussed at a prior City Council meeting, and/or they do not warrant Council deliberation. If you would like to discuss one of these items, please do so during "Open Forum."

1. Consider approval of the minutes from the September 18, 2023 city council meeting, and take any action necessary.

2. **Z2023-038** - Consider a request by the City of Rockwall for the approval of an **ordinance** for a Zoning Change amending Planned Development District 3 (PD-3) [Ordinance No.'s 72-02, 77-19A, 80-33, 84-59, 86-23, 86-39, 89-04, 96-35 & 96-23] for the purpose of consolidating the regulating ordinances for a 639.264-acre tract of land situated within the T. Dean Survey, Abstract No. 69; S. King Survey, Abstract No. 131; N. Butler Survey, Abstract No. 21; and, A. Hanna Survey, Abstract No. 98, City of Rockwall, Rockwall County, Texas, zoned Planned Development District 3 (PD-3), generally located south of Dalton Road, west of SH-205 [S. Goliad Street], and north of Lake Forest Drive, and take any action necessary **(2nd Reading)**.
3. **Z2023-039** - Consider approval of an **ordinance** for a Text Amendment to Subsection 06.16, *Lake Ray Hubbard Takeline Overlay (TL OV) District*, of Article 05, *District Development Standards*, of the Unified Development Code (UDC) [Ordinance No. 20-02] for the purpose of creating a process to allow Homeowner's Associations (HOA's) the ability to lease certain portions of the takeline, and take any action necessary **(2nd Reading)**.
4. **Z2023-040** - Consider a request by Kaylee and Taylor Henson for the approval of an **ordinance** for a Specific Use Permit (SUP) for *Residential Infill Adjacent to an Established Subdivision* on a ten (10) acre parcel of land identified as Lot 1, Block A, Breezy Hill Lane Addition, City of Rockwall, Rockwall County, Texas, zoned Agricultural (AG) District, addressed as 1325 Breezy Hill Lane, and take any action necessary **(2nd Reading)**.
5. **Z2023-041** - Consider a request by Anthony Loeffel of Kimley-Horn on behalf of James Melino of Rockwall 549/I-30 Partners, LP and Conveyer I30 Partners, LP for the approval of an **ordinance** for a Zoning Change from a Agricultural (AG) District and Light Industrial (LI) District to a Commercial (C) District for a 66.057-acre tract of land identified as Lot 1, Block B; Lot 1R, Block C; and Lot 1, Block D, Rockwall Commercial Addition, City of Rockwall, Rockwall County, Texas, zoned Agricultural (AG) District and Light Industrial (LI) District, situated within the IH-30 Overlay (IH-30 OV) District, generally located at the northwest corner of Stodghill Road and the IH-30 Frontage Road, and take any action necessary **(2nd Reading)**.
6. **Z2023-042** - Consider a request by Juan J. Vasquez of Vasquez Engineering, LLC on behalf of Shane Shoulders of Kennor Rockwall Retail, LLC for the approval of an **ordinance** for a Specific Use Permit (SUP) for a *Restaurant, with 2,000 SF or More, with Drive-Through or Drive-In* on a 1.93-acre parcel of land identified as Lots 8 & 9, Block A, Dalton-Goliad Addition, City of Rockwall, Rockwall County, Texas, zoned General Retail (GR) District, situated within the North SH-205 Overlay (N. SH-205 OV) District, addressed as 3611 & 3775 N. Goliad Street [SH-205], and take any action necessary **(2nd Reading)**.
7. **Z2023-043** - Consider a request by Angelina Nguyen for the approval of an ordinance for a Specific Use Permit (SUP) for Residential Infill In an Established Subdivision on a 0.16-acre parcel of land identified as Lot 18, Block B, Harbor Landing, Phase 2 Addition, City of Rockwall, Rockwall County, Texas, zoned Planned Development District 8 (PD-8), addressed as 303 Harborview Drive, and take any action necessary **(2nd Reading)**.
8. Consider approval of an **ordinance** amending Chapter 28 of the city's Code of Ordinances to establish the Rockwall Municipal Court as a Court of Record, and take any action necessary **(2nd reading)**.

9. **P2023-030** - Consider a request by Ashley Egan for the approval of a Final Plat for Lot 1, Block A, Reborn Skin Addition being a 0.51-acre tract of land identified as Block 80B of the B.F. Boydston Addition, City of Rockwall, Rockwall County, Texas, zoned Residential-Office (RO) District, addressed as 108 St. Mary's Street, and take any action necessary.
10. Consider a request by Bowen Hendrix of DuWest Realty, LLC for the approval of an Alternative Tree Mitigation Settlement Agreement in conjunction with an approved site plan for two (2) Restaurant/Retail Buildings on an 8.63-acre tract of land identified as Tract 3-10 of the S. King Survey, Abstract No. 131, City of Rockwall, Rockwall County, Texas, being zoned Planned Development District 70 (PD-70) for limited General Retail (GR) District land uses, situated within the North SH-205 Overlay (N. SH-205 OV) District, generally located at the northeast corner of the intersection of E. Quail Run Road and N. Goliad Street [SH-205], and take any action necessary.
11. Consider authorizing the City Manager to execute an interlocal cooperative agreement between the City of Rockwall and STAR Transit for transportation services for fiscal year 2024 in the amount of \$121,000 to be funded by the Administration Department Operating Budget, and take any action necessary.
12. Consider authorizing the City Manager to execute an agreement with Meals on Wheels Senior Services for certain nutritional and senior service programs for fiscal year 2024 in the amount of \$50,000 to be funded from the Administration Department Operating Budget, and take any action necessary.
13. Consider authorizing the City Manager to execute an interlocal agreement between the City of Rockwall and Rockwall County for Animal Control Services, and take any action necessary.
14. Consider authorizing the City Manager to execute a purchase order with Facility Solutions Group/Green Frog System in the amount of \$165,280.80 for installation of solar lighting at Kidzone playground and Harry Myers parking lots to be funded out of the Recreation Development Fund (this is an approved 2023-2024 budget request funded at \$185,000.00), and take any action necessary.
15. Consider authorizing the City Manager to execute a purchase order with Master Systems Courts in the amount of \$55,000.00 for the resurfacing of pickleball and basketball courts to be funded out of the Recreation Development Fund (this is an approved 2023-2024 budget request with approved funding of \$55,000.00), and take any action necessary.
16. Consider authorizing the City Manager to execute a purchase order with Horizon Online Distributors in the amount of \$48,081.90 for the purchase of Toro Dingo XT1000 Tractor to be funded out of Parks Budget (this is an approved 2023-2024 budget request funded at \$55,000.00), and take any action necessary.
17. Consider authorizing the City Manager to execute an amendment with Rockwall Adoption Center related to funding for fiscal year 2024, and take any action necessary.

X. Action Items

If your comments are regarding an agenda item below, you are asked to speak during Open Forum.

1. Discuss and consider approval of a resolution providing for the submission of names to the Rockwall Central Appraisal District (CAD / RCAD) for nominations to the Board of Directors, and take any action necessary.
2. Consider approval of a recommendation from the Hotel Occupancy Tax (HOT) Subcommittee appropriating funding for the Chamber of Commerce in the amount of \$465,000, and take any action necessary.
3. Discuss and consider a recommendation by the Parks & Recreation Board, including approval of a resolution naming 50 acres of dedicated park land the "Ben A. Klutts Sr. Park," and take any action necessary.
4. Discuss and consider approval of the Rockwall Baseball Softball League's Zero Tolerance Umpire Policy, and take any action necessary.

XI. City Manager's Report, Departmental Reports and Related Discussions Pertaining To Current City Activities, Upcoming Meetings, Future Legislative Activities, and Other Related Matters.

1. Building Inspections Department Monthly Report - August 2023
2. Fire Department Monthly Report - August 2023
3. Parks & Recreation Department Monthly Report - August 2023
4. Police Department Monthly Report - August 2023
5. Sales Tax Historical Comparison
6. Water Consumption Historical Statistics

XII. Adjournment

This facility is wheelchair accessible and accessible parking spaces are available. Request for accommodations or interpretive services must be made 48 hours prior to this meeting. Please contact the City Secretary's Office at (972) 771-7700 or FAX (972) 771-7727 for further information.

The City of Rockwall City Council reserves the right to adjourn into executive session at any time to discuss any of the matters listed on the agenda above, as authorized by Texas Government Code ¶ 551.071 (Consultation with Attorney) ¶ 551.072 (Deliberations about Real Property) ¶ 551.074 (Personnel Matters) and ¶ 551.087 (Economic Development)

I, Kristy Teague, City Secretary for the City of Rockwall, Texas, do hereby certify that this Agenda was posted at City Hall, in a place readily accessible to the general public at all times, on the 29th day of September, at 4:30 PM and remained so posted for at least 72 continuous hours preceding the scheduled time of said meeting.

Kristy Teague, City Secretary
or Margaret Delaney, Asst. to the City Sect.

Date Removed

Rockwall,



Texas

Proclamation

Whereas, according to the National Coalition Against Domestic Violence:

- In the United States, more than 10 million adults experience domestic violence annually;
- 1 in 3 women and 1 in 4 men has been physically abused by an intimate partner, with 1 in 4 women and 1 in 7 men having been severely physically abused;
- On a typical day, domestic violence hotlines, nationwide, receive over 19,000 calls;
- Domestic victimization is correlated with a higher rate of depression and suicidal behavior; and

Whereas, domestic violence includes physical violence, sexual violence, threats, economic, and emotional/psychological abuse; and

Whereas, domestic violence is prevalent in every community, affecting people regardless of age, socioeconomic status, sexual orientation, gender, race or nationality; and

Whereas, any external factors that add stress, isolation, and financial strain can create circumstances where a survivor's safety is further compromised; and

Whereas, only 34% of people who are injured by intimate partners receive medical care for their injuries; and

Whereas, those who are abused often don't leave the relationship for many reasons, such as fear that the abuser's violent behavior will escalate if he or she tries to leave; the hope that the abuser may change; or religious or cultural beliefs that prevent a person from leaving;

Whereas, domestic violence can result in physical injury, mental trauma, and even death, with children often falling victim as well.

Now, Therefore, I, Trace Johannesen, Mayor of the City of Rockwall, Texas, do hereby proclaim the month of October as:

Domestic Violence Awareness Month

in the City of Rockwall and encourage all citizens to help raise awareness about domestic violence in our community, to support organizations that aim to eradicate this crime and to assist those affected.

In Witness Whereof, I hereunto set my hand and official seal this 2nd day of October, 2023.

Trace Johannesen, Mayor

Rockwall,  Texas
Proclamation

Whereas, for the last forty years, the National Association of Town Watch sponsors a nationwide crime, drug and violence prevention program called “National Night Out, America’s Night Out Against Crime;” and

Whereas, this annual event provides a unique opportunity for Rockwall to join forces with thousands of communities across the country to promote cooperative, police-community crime prevention efforts; and

Whereas, Rockwall residents play a vital role in assisting the Rockwall Police Department by participating in crime, drug and violence prevention efforts and supporting this annual event; and

Whereas, it is essential that our residents be aware of the importance of crime prevention programs and the impact their participation can have on reducing crime in Rockwall; and

Whereas, police-community partnerships, neighborhood safety, awareness and cooperation are all important themes of the “National Night Out” program; and

Whereas, every year thousands of Rockwall residents participate in “Texas Night Out” by turning on porch lights, spending the evening outside with neighbors, and hosting block parties, cookouts, and parades, with each of these events being attended by Rockwall Police Department officers; and

Whereas, these community-based events unite citizens of Rockwall against crime, reinforce community-police partnerships and strengthen neighborhood spirit.

Now, Therefore I, Trace Johannesen, Mayor of the City of Rockwall do hereby proclaim **October 3, 2023** as

NATIONAL NIGHT OUT



in the City of Rockwall and call upon all citizens to join the Rockwall Police Department and the National Association of Town Watch in supporting “National Night Out” events being held throughout our city.

In Witness Whereof, I hereunto set my hand and seal this 2nd day of October 2023.

Trace Johannesen, Mayor

Rockwall,  Texas
Proclamation

Whereas, the City of Rockwall is committed to ensuring the safety and security of all those living in and visiting Rockwall; and

Whereas, fire is a serious public safety concern, both locally and nationally, and homes are where people are at greatest risk from fire; and

Whereas, according to the National Fire Protection Association, in 2021 home fires killed more than 2,800 people in the U.S., and fire departments nationwide responded to 338,000 home fires; and

Whereas, cooking fires are the leading cause of home fires and home fire injuries, with unattended cooking being the leading cause of cooking fires and deaths; and

Whereas, Rockwall residents can help avoid such tragedies by turning pot handles toward the back of the stove; always keeping a lid nearby when cooking; keeping a three-foot kid-free zone around the stove, oven, and other things that could get hot; watching what they heat; and setting a timer to remind them they are cooking; and

Whereas residents who have planned and practiced a home fire escape plan are more prepared and are therefore more likely to survive a fire; and

Whereas working smoke alarms cut the risk of dying in home fires almost in half; and

Whereas, the 2023 Fire Prevention theme, “**Cooking Safety Starts With YOU! Pay Attention to Fire Prevention,**” effectively serves to remind us to stay alert and use caution when cooking to reduce the risk of kitchen fires.

Now, Therefore I, Trace Johannesen, Mayor of the City of Rockwall do hereby proclaim **October 2023** as

FIRE PREVENTION MONTH

in the City of Rockwall and urge all residents to check their kitchens for fire hazards, use safe cooking practices, and support the various public safety activities and efforts of the Rockwall Fire Department.

In Witness Whereof, I hereunto set my hand and seal this 2nd day of October 2023.

Trace Johannesen, Mayor

ROCKWALL CITY COUNCIL REGULAR MEETING
Monday, September 18, 2023 - 5:00 PM
City Hall Council Chambers - 385 Goliad St., Rockwall, TX 75087

I. Call Public Meeting to Order

Mayor Johannesen called the public meeting to order at 6:00 p.m. Present were Mayor Trace Johannesen, Mayor Pro Tem Anna Campbell, and Councilmembers Sedric Thomas, Mark Moeller, Clarence Jorif, Dennis Lewis and Tim McCallum. Also present were City Manager, Mary Smith; Assistant City Manager, Joey Boyd; and City Attorney, Frank Garza. High school students from the city's Youth Advisory Council (YAC) program were also present during this meeting.

Councilmember Johannesen read the below listed discussion items into the record before recessing the public meeting to go into Executive Session at 5:01 p.m.

II. Executive Session

The City of Rockwall City Council will recess into executive session to discuss the following matter as authorized by chapter 551 of the Texas government code:

1. Discussion regarding (re)appointments to city regulatory boards and commissions, pursuant to §551.074 (Personnel Matters)
2. Discussion regarding Municipal Court operations, pursuant to Section 551.071 (Consultation with Attorney).
3. Discussion regarding candidates and associated election for the Rockwall Central Appraisal District (CAD) Board of Directors, pursuant to Section 551.074 (personnel matters)

III. Adjourn Executive Session

Council adjourned from Executive Session at 5:35 p.m.

IV. Reconvene Public Meeting (6:00 P.M.)

Mayor Johannesen reconvened the public meeting at 6:00 p.m.

V. Invocation and Pledge of Allegiance - Councilmember McCallum

Councilmember McCallum delivered the invocation and led the Pledge of Allegiance.

VI. Proclamations / Awards / Recognitions

1. Constitution Week

Mayor Johannesen came forth, along with a few members of the Daughters of the American Revolution.

2. Swearing in of newly appointed Youth Advisory Council (YAC) members

City Secretary, Kristy Teague explained brief details regarding the “Oath of Office” in the State of Texas. She then asked the eleven Youth Advisory Council students who were present to rise, and she helped administer to them their Oaths of Office.

VII. Appointment Items

1. Appointment with Planning & Zoning Commission representative to discuss and answer any questions regarding planning-related cases on the agenda.

The P&Z Commission representative was not present for the meeting, so this agenda item was not addressed.

VIII. OPEN FORUM

Mayor Johnnesen explained how Open Forum is conducted, asking if anyone would like to come forth and speak at this time.

Palette Weddle
1601 S. Alamo Road
Rockwall, TX 75087

Mrs. Weddle indicated that she has lived in Rockwall for forty-seven years. She expressed she has some concerns about an Air B&B that has been recently established at 1400 Ridge Road, which is a home that used to be owned by Dan Bobst but he sold it. It is her understanding that the Air B&B has room for sixteen people, as it is quite a large house. The house has a very large garage by the alleyway, and Mrs. Weddle’s home backs up to the alley. She believes they are planning to use that garage as a ‘party barn.’ She went on to express concerns about this as well as a tennis court that may have been built without approval. She is hoping the city does not let that property get out of hand. She has a lot of concerns and will be fighting these concerns. Her other concern is related to the end of the alleyway near Becky Lane and South Alamo, as either the recycling truck or the garbage truck made a turn and fell into the hole. She explained that the alleyway is beginning to buckle, and this has been an eyesore for quite some time now.

Mayor Johannesen shared that the city has been discussing ‘short term rentals’ (such as Air B&B’s), trying to strike a balance between regulating those and private property rights. Mrs. Weddle shared that there are two additional short-term rentals near where she lives, and one of them in particular is not being maintained (dead trees and shrubs).

Amy Herbst
1509 S. Alamo Road
Rockwall, TX 75087

Mrs. Herbst stated that Mrs. Weddle is her neighbor. She explained that her home was fairly newly built, and she has lived there for about three years. She also has concerns about the Air B&B Mrs. Weddle spoke of this evening. She too has concerns about the one at 1400 Ridge Road being utilized as a ‘party barn,’ as there is only about 10’ between that property and her property. She is worried about her property values and is concerned that the Air B&B will not be properly maintained. She believes that a “use” like this should be more for “Commercial” use and that it should not be allowed within a residential neighborhood.

**Stan Jeffus
2606 Cypress Drive
Rockwall, TX 75087**

Mr. Jeffus came forth and expressed concern about traffic within our city. He generally expressed concerns about additional subdivisions that have recently been approved by the Council / the city and within the last few months and how those will be contributing to unfavorable and additional traffic within the city. He indicated that some folks are moving out of Rockwall because of all of the traffic. He generally spoke about concerns related to infrastructure and traffic accidents that are happening daily, and he wonders if there is anyway that additional development(s) could be avoided / not approved by the city moving forward.

Mayor Johannesen shared that on the 3rd Wednesday monthly a countywide Traffic Consortium meets to discuss the many state-owned roadways and

IX. Take Any Action as a Result of Executive Session

Councilmember Lewis moved to appoint Brook Roy to the city's ART Commission to fill a vacant seat with an initial term to run through August of 2024. Councilmember Moeller seconded the motion, which passed unanimously of those present (7 ayes to 0 nays).

Councilmember Thomas moved to appoint Eric Smith to the city's Board of Adjustments (in the 'Alternate Board Member' vacant seat, through August of 2024); Councilmember Jorif seconded the motion, which passed unanimously of those present (7 ayes to 0 nays).

X. Consent Agenda

- 1. Consider approval of the minutes from the September 5, 2023, city council meeting, and take any action necessary.**
- 2. Consider authorizing the City Manager to execute an interlocal agreement between the City of Rockwall and the City of Fate for emergency dispatch and radio system support services for fiscal year 2024, and take any action necessary.**
- 3. Consider authorizing the City Manager to execute an interlocal agreement between the City of Rockwall and the City of Heath for emergency dispatch and radio system support services for fiscal year 2024, and take any action necessary.**
- 4. Consider authorizing the City Manager to execute an Interlocal Agreement with Rockwall Independent School District for School Resource Officer services for school calendar year 2023-2024, and take any action necessary.**
- 5. Consider authorizing the City Manager and Fire Chief to execute an interlocal agreement with Rockwall County for Fire Protection Services for fiscal year 2024, and take any action necessary.**
- 6. Consider approval of a resolution affirming the city's investment policy, and take an action necessary**

Councilmember McCallum moved to approve the entire Consent Agenda (#s 1, 2, 3, 4, 5, and 6). Councilmember Jorif seconded the motion, which passed by a vote of 7 ayes to 0 nays.

XI. Public Hearing Items

- 1. Z2023-038** - Hold a public hearing to discuss and consider a request by the City of Rockwall for the approval of an **ordinance** for a Zoning Change amending Planned Development District 3 (PD-3) [*Ordinance No.'s 72-02, 77-19A, 80-33, 84-59, 86-23, 86-39, 89-04, 96-35 & 96-23*] for the purpose of consolidating the regulating ordinances for a 639.264-acre tract of land situated within the T. Dean Survey, Abstract No. 69; S. King Survey, Abstract No. 131; N. Butler Survey, Abstract No. 21; and, A. Hanna Survey, Abstract No. 98, City of Rockwall, Rockwall County, Texas, zoned Planned Development District 3 (PD-3), generally located south of Dalton Road, west of SH-205 [*S. Goliad Street*], and north of Lake Forest Drive, and take any action necessary (**1st Reading**).

Planning Director, Ryan Miller provided background information on this agenda item. On June 5, 2023, the City Council directed staff to begin the process of initiating zoning to amend the City's older Planned Development (PD) Districts in order to prepare consolidating ordinances (i.e. writing one ordinance that supersedes all previous ordinances for the Planned Development Districts). The purpose of this effort is to [1] make zoning easier to understand for the City's external customers (i.e. developers, homebuilders, and citizens), and [2] to make the zoning ordinances easier to interpret internally by City staff; however, the proposed consolidating ordinances are not intended to change any of the requirements, land uses, concept plans, or development standards stipulated for any Planned Development (PD) District. This was successfully done recently to the Planned Development (PD) District for the Chandler's Landing Subdivision (i.e. Planned Development District 8 [PD-8]). This ordinance serves the same purpose. Staff sent out 2,216 notices to all property owners and occupants of the Shores Subdivision and within 500-feet of the Shores Subdivision. In addition, staff notified the Rockwall Shores, the Shores on Lake Ray Hubbard, the Random Oaks/Shores, Promenade Harbor, Harlan Park, Stone Creek, Lakeview Summit, the Preserve, and the Hillcrest at the Shores Homeowner's Associations (HOAs), which were the only HOAs within 1,500-feet of the subject property. To date, staff has received

- (1) Two (2) property owner notifications from two (2) property owners located within the Shores Subdivision in favor of the proposed amendment.
- (2) Two (2) property owner notifications from two (2) property owners located within the Shores Subdivision opposed to the proposed amendment (staff should point out that neither notice seem to address the intent of the case).
- (3) Two (2) property owner notifications from two (2) property owners located within the 500-foot notification buffer, but outside of the Shores Subdivision in favor of the proposed amendment.
- (4) One (1) email from one (1) property owner outside of the Shores Subdivision in favor of the proposed amendment.
- (5) One (1) response from the online Zoning & Specific Use Permit Input Form from one (1) property owner in the Shores Subdivision in favor of the proposed amendment.
- (6) One (1) response from the online Zoning & Specific Use Permit Input Form from one (1) property owner in the Shores Subdivision indicating being both in favor and opposed to the proposed amendment.

Mr. Miller stressed that nothing about this ordinance will in any way change the fact that the streets within The Shores subdivision will still remain public streets – they will not be privatized, and this ordinance will not affect the road ways in any way. On September 12, 2023, the Planning and Zoning Commission approved a motion to recommend approval of the case by a vote of 6-0, with Commissioner Womble absent.

Mayor Johannesen opened the public hearing, asking if anyone would like to come forth and speak. There being no one indicating such, he then closed the public hearing.

Councilmember McCallum moved to approve Z2023-038. Councilmember Lewis seconded the motion. The ordinance caption was read as follows:

CITY OF ROCKWALL

ORDINANCE NO. 23-XX

AN ORDINANCE OF THE CITY COUNCIL OF THE CITY OF ROCKWALL, TEXAS, AMENDING PLANNED DEVELOPMENT DISTRICT 3 (PD-3) AND THE UNIFIED DEVELOPMENT CODE [ORDINANCE NO. 20-02] OF THE CITY OF ROCKWALL, AS HERETOFORE AMENDED, SO AS TO CONSOLIDATE THE REGULATING ORDINANCES OF THE PLANNED DEVELOPMENT DISTRICT, BEING A 639.264-ACRE TRACT OF LAND SITUATED WITHIN THE T. DEAN SURVEY, ABSTRACT NO. 69; S. KING SURVEY, ABSTRACT NO. 131; N. BUTLER SURVEY, ABSTRACT NO. 21; AND, A. HANNA SURVEY, ABSTRACT NO. 98, CITY OF ROCKWALL, ROCKWALL COUNTY, TEXAS AND MORE FULLY DESCRIBED HEREIN BY *EXHIBIT 'A'* AND DEPICTED HEREIN BY *EXHIBIT 'B'*; PROVIDING FOR SPECIAL CONDITIONS; PROVIDING FOR A PENALTY OF FINE NOT TO EXCEED THE SUM OF TWO THOUSAND DOLLARS (\$2,000.00) FOR EACH OFFENSE; PROVIDING FOR A SEVERABILITY CLAUSE; PROVIDING FOR A REPEALER CLAUSE; PROVIDING FOR AN EFFECTIVE DATE.

The motion to approve passed unanimously (7 ayes to 0 nays).

2. **Z2023-039** - Hold a public hearing to discuss and consider approval of an ordinance for a Text Amendment to Subsection 06.16, *Lake Ray Hubbard Takeline Overlay (TL OV) District*, of Article 05, *District Development Standards*, of the Unified Development Code (UDC) [Ordinance No. 20-02] for the purpose of creating a process to allow Homeowner's Associations (HOA's) the ability to lease certain portions of the takeline, and take any action necessary (**1st Reading**).

Planning Director, Ryan Miller provided background information on this agenda item. On August 7, 2023, the City Council directed staff to amend Subsection 06.16, *Lake Ray Hubbard Takeline Overlay (TL OV) District*, of Article 05, *District Development Standards*, of the Unified Development Code (UDC) to add language that would allow certain Homeowner's Associations (HOAs) the ability to lease non-leasable areas adjacent to their jurisdictional boundaries. The purpose of this proposal is to allow certain HOAs the ability to make improvements in the takeline area in exchange for the necessary erosion control improvements needed to prevent or fix erosion on non-leasable areas without subjugating the City to the maintenance of these structures moving forward. In researching this amendment, staff identified four HOAs that could be eligible to lease areas of the takeline that are currently unleaseable. These include: [1] the Chandler's Landing Subdivision (i.e. adjacent to Blocks B & C, Chandler's Landing, Phase 17), [2] the Signal Ridge Subdivision (i.e. adjacent to Signal Ridge, Phase 4), [3] the Water's Edge Subdivision at Lake Ray Hubbard (aka Villas De Portofino), and [4] the Lakeside Village Subdivision. This ordinance, if approved, will create certain requirements associated with lease of the takeline for these HOAs. Also, staff is presenting an updated "Sublease Agreement" that will allow HOAs to sublease takeline areas. On September 12, 2023, the Planning and Zoning Commission approved a motion to recommend approval of the text amendment as written by a vote of 6-0, with Commissioner Womble absent.

Mayor Johannesen opened the public hearing, asking if anyone would like to come forth and speak. There

being no one indicating such, he then closed the public hearing.

Mayor Pro Tem Campbell moved to approve Z2023-039. Councilmember Thomas seconded the motion. The ordinance caption was read as follows:

CITY OF ROCKWALL
ORDINANCE NO. 23-XX

AN ORDINANCE OF THE CITY COUNCIL OF THE CITY OF ROCKWALL, TEXAS, AMENDING THE UNIFIED DEVELOPMENT CODE [*ORDINANCE NO. 20-02*] OF THE CITY OF ROCKWALL, AS HERETOFORE AMENDED, BY AMENDING ARTICLE 05, *DISTRICT DEVELOPMENT STANDARDS*, AS DEPCITED IN *EXHIBIT 'A'* OF THIS ORDINANCE; PROVIDING FOR A PENALTY OF FINE NOT TO EXCEED THE SUM OF TWO THOUSAND DOLLARS (\$2,000.00) FOR EACH OFFENSE; PROVIDING FOR A SEVERABILITY CLAUSE; PROVIDING FOR A REPEALER CLAUSE; PROVIDING FOR AN EFFECTIVE DATE.

The motion to approve passed unanimously (7 ayes to 0 nays).

3. **Z2023-040** - Hold a public hearing to discuss and consider a request by Kaylee and Taylor Henson for the approval of an ordinance for a *Specific Use Permit (SUP)* for Residential Infill Adjacent to an Established Subdivision on a ten (10) acre parcel of land identified as Lot 1, Block A, Breezy Hill Lane Addition, City of Rockwall, Rockwall County, Texas, zoned Agricultural (AG) District, addressed as 1325 Breezy Hill Lane, and take any action necessary (**1st Reading**).

Planning Director, Ryan Miller provided background information on this agenda item. He explained that the applicant is requesting an SUP in order to construct a single-family home on this 10 acre parcel of land, which is located at 1325 Breezy Hill Lane. In this case, the subject property shares a common boundary (i.e. the western property line) with the Breezy Hill Subdivision, which has been in existence since 2008, consists of more than five (5) lots, and is more than 90% developed. Council is being asked to consider the size, location and architecture of this proposed home as compared to the existing, nearby homes when making a discretionary decision regarding approval or disapproval of this SUP request. There are three (3) vacant parcels of land that are in close proximity to the home. These lots are estate style lots (i.e. larger lots) as opposed to the more traditional style lots with single-family homes in Phase 8 of the Breezy Hill Subdivision. Staff should note that the proposed single-family home meets all of the density and dimensional requirements for a home in an Agricultural (AG) District as stipulated by the Unified Development Code (UDC).

Mayor Johannesen opened the public hearing, asking if anyone would like to come forth and speak.

Kara Balderas
4602 Sky Harbor
Rockwall, TX

Mrs. Balderas came forth and indicated that she feels not enough information has been provided in the informational public meeting packets concerning this item. She wonders if they will be paving the roadway, and she has concerns about where the driveway at this property will be located. Her home backs up directly to this property. She stated that concrete was recently being poured at 3:00 a.m., and, although she called the police and sheriffs departments, no one showed up to address the issue. She also recently had to call the police about a suspicious vehicle. She has concerns about not having personally received a zoning notice

in the mail, and some of her neighbors indicated that they did not receive their notices until last week. So she has concerns about when the notices were sent out, especially considering USPS delays.

Mr. Miller shared details of where the driveway is going to be situated (off of Breezy Hill Lane, about in the midpoint of the property). Also, they will not be paving the roadway. He explained that this property is subject to an agreement that has been in place long before this phase of the Breezy Hill subdivision was constructed. The agreement always stipulated that only two homes would be permitted, each on a 10-acre tract of land. He explained that these two properties are located within the city, so anything happening on them will be subject to city regulations. Just south of these properties, those tracts are located outside of the city's city limits. He explained that city staff mailed notices out one week after these cases were received. By law, staff must send them out 10 days prior to the public hearing; however, the city always sends out notices even earlier than what is called for. Unfortunately, the city cannot control the US post office. Also, there should not be any construction going on prior to 7:00 a.m., so Mr. Miller encouraged her to contact the city's police department in the future if anything like that is going on prior to 7:00 a.m.

Mayor Pro Tem Campbell moved to approve Z2023-040. Councilmember Jorif seconded the motion. Councilmember McCallum clarified that this property will remain as an "AG" zoned property. The ordinance caption was then read as follows:

CITY OF ROCKWALL
ORDINANCE NO. 23-XX
SPECIFIC USE PERMIT NO. S-2XX

AN ORDINANCE OF THE CITY COUNCIL OF THE CITY OF ROCKWALL, TEXAS, AMENDING THE UNIFIED DEVELOPMENT CODE (UDC) [ORDINANCE NO. 20-02] OF THE CITY OF ROCKWALL, ROCKWALL COUNTY, TEXAS, AS PREVIOUSLY AMENDED, SO AS TO GRANT A SPECIFIC USE PERMIT (SUP) FOR *RESIDENTIAL INFILL ADJACENT TO AN ESTABLISHED SUBDIVISION* TO ALLOW THE CONSTRUCTION OF A SINGLE-FAMILY HOME ON A 10.00-ACRE TRACT OF LAND, IDENTIFIED AS LOT 1, BLOCK A, BREEZY HILL LANE ADDITION, CITY OF ROCKWALL, ROCKWALL COUNTY, TEXAS; AND MORE SPECIFICALLY DESCRIBED AND DEPICTED IN *EXHIBIT 'A'* OF THIS ORDINANCE; PROVIDING FOR SPECIAL CONDITIONS; PROVIDING FOR A PENALTY OF FINE NOT TO EXCEED THE SUM OF TWO THOUSAND DOLLARS (\$2,000.00) FOR EACH OFFENSE; PROVIDING FOR A SEVERABILITY CLAUSE; PROVIDING FOR A REPEALER CLAUSE; PROVIDING FOR AN EFFECTIVE DATE.

The motion passed by a vote of 7 ayes to 0 nays.

4. **Z2023-041** - Hold a public hearing to discuss and consider a request by Anthony Loeffel of Kimley-Horn on behalf of James Melino of Rockwall 549/I-30 Partners, LP and Conveyor I30 Partners, LP for the approval of an **ordinance** for a Zoning Change from a Agricultural (AG) District and Light Industrial (LI) District to a Commercial (C) District for a 66.057-acre tract of land identified as Lot 1, Block B; Lot 1R, Block C; and Lot 1, Block D, Rockwall Commercial Addition, City of Rockwall, Rockwall County, Texas, zoned Agricultural (AG) District and Light Industrial (LI) District, situated within the IH-30 Overlay (IH-30 OV) District, generally located at the northwest corner of Stodghill Road and the IH-30 Frontage Road, and take any action necessary **(1st Reading)**.

Planning Director, Ryan Miller provided background information on this agenda item. He shared that the property was originally annexed into the city in December of 1985 and was initially zoned AG. At this time the applicant is requesting a change in zoning from an AG and LI District to a Commercial district in order to facilitate future conveyance of the property. The property is generally located at the northwest corner of Stodghill Road (FM-3549) and the IH-30 westbound frontage road. Mr. Miller briefly described the zoning of adjacent properties. This zoning change request is consistent with the city's Unified Development Code and conforms to the OURHometown Vision 2040 Comprehensive Plan. In addition, this a discretionary decision on the part of Council, pending a recommendation from the city's Planning & Zoning Commission. Based on the proposed request, the applicant is not proposing to develop the subject property; however, when the property is developed the following infrastructure is required to be constructed to provide adequate public services for the subject property:

- (1) **Water Improvements.** The development of the subject property will require the construction of a 12-inch waterline per the Master Water Distribution Plan.
- (2) **Sewer Improvements.** The development of the subject property will require the extension of the existing 12-inch wastewater line in Justin Road to Stodghill Road [FM-3549].
- (3) **Roadways.** Justin Road is identified as an A4D (i.e. major arterial, four [4] lane, divided roadway), which requires a minimum of an 85-foot right-of-way and two (2), 25-foot back-to-back concrete streets with a 14-foot median. Currently, half of this roadway has been constructed. When developed the remaining portion of this roadway and any lights or appurtenances will need to be provided. In addition, the applicant will need to construct a five (5) foot sidewalk along Justin Road and/or any other public rights-of-way.
- (4) **Drainage.** Detention will be required and sized per the Engineering Department's *Standards of Design and Construction Manual*

On August 22, 2023, staff mailed 30 notices to property owners and occupants within 500-feet of the subject property. There are no Homeowner's Associations (HOAs) or Neighborhood Organizations within 1,500-feet of the subject property participating in the Neighborhood Notification Program. Staff received one notice in favor of the request and none in opposition. In addition, the city's Planning & Zoning Commission voted 6 – 0 on September 12, 2023 to recommend approval of this zoning change request.

Mayor Johannesen opened the public hearing, asking if anyone would like to come forth and speak.

Stan Jeffus
2606 Cypress Drive
Rockwall, TX 75087

Mr. Jeffus came forth and shared that this property is 'in his backyard.' He has spoken to several people who have told him that this location is slated for a 16,000 square foot IKEA store. He would like to know what is going on, as he believes this corner currently has horrible traffic, and an IKEA store will just exacerbate the issues. He has heard various rumors, but people he has talked to at the city have told him it is going to be an IKEA store. He wonders what decisions will be made to keep traffic under control.

Mayor Johannesen indicated that the original plans submitted to the City by an engineering firm erroneously had a store name on them; however, that mistake was corrected immediately, and the store name was removed. Today, the applicant is solely asking to change the zoning, and the request is in compliance with the city's Comprehensive Plan. The city does not know for sure what business may end up going in at this location.

Mr. Jeffus acknowledged that notice were mailed to about 30 adjacent property owners, but he wonders

why notices are not mailed to everyone who traverses that particular intersection / location. Or, perhaps the city could publicize it in the paper. Mayor Johannesen pointed out that the city would have no way to notify drivers who pass through that intersection. Also, these zoning cases are advertised in the newspaper, and they are also placed online and out front of city hall. Mr. Jeffus expressed that a lot of members of the public do not stay involved and do not know what is going on.

Councilmember Lewis asked Mr. Jeffus what sort of development he would prefer to see at this location, knowing that it will eventually be developed. Mr. Jeffus shared that he would prefer it be open space with cows, or – if that’s not possible – then something that would not create a lot of additional traffic and/or traffic jams. Mrs. Melba Jeffus then spoke briefly, sharing large concerns that this location will become an IKEA store at some point. She was not happy about that possibility.

Councilmember McCallum shared that rumors fly all over this town, and he too has heard a lot of these rumors. However, all he can personally deal with related to this particular zoning case is the facts. If the city is going to keep taxes low, our sales taxes generate more revenue than the rooftops do in our city. If we want to continue keeping the tax rate low and/or lower it annually, the city has got to consider fantastic developments along IH-30. The Council does have an ability to make a lot of decisions, and developers have to follow the city’s Comprehensive Plan. The elected officials have to ensure that good services are provided and that more sales tax growth along IH-30 is fueled. He does not want more car lots or additional business that do not result in increased sales tax revenue. If it is IKEA or if it another business that buys and develops the land, the Council will make whatever wise decisions it needs to make at that point, moving forward. For now, this particular case tonight is just a zoning change case.

Having said that, Councilmember McCallum moved to approve Z2023-041. Councilmember Thomas seconded the motion. Mayor Johannesen echoed Councilman McCallum’s sentiments that the Council can only consider the facts about what is currently being presented to it associated with this zoning change request tonight. The ordinance caption was read as follows:

CITY OF ROCKWALL

ORDINANCE NO. 23-XX

AN ORDINANCE OF THE CITY COUNCIL OF THE CITY OF ROCKWALL, TEXAS, AMENDING THE UNIFIED DEVELOPMENT CODE [ORDINANCE NO. 20-02] OF THE CITY OF ROCKWALL, AS HERETOFORE AMENDED, SO AS TO APPROVE A CHANGE IN ZONING FROM AN AGRICULTURAL (AG) DISTRICT AND A LIGHT INDUSTRIAL (LI) DISTRICT TO A COMMERCIAL (C) DISTRICT FOR A 66.057-ACRE TRACT OF LAND IDENTIFIED AS LOT 1, BLOCK B; LOT 1R, BLOCK C; AND LOT 1, BLOCK D, ROCKWALL COMMERCIAL ADDITION, CITY OF ROCKWALL, ROCKWALL COUNTY, TEXAS, AND BEING MORE SPECIFICALLY DESCRIBED IN EXHIBIT ‘A’ AND FURTHER DEPICTED IN EXHIBIT ‘B’ OF THIS ORDINANCE; PROVIDING FOR SPECIAL CONDITIONS; PROVIDING FOR A PENALTY OF FINE NOT TO EXCEED THE SUM OF TWO THOUSAND DOLLARS (\$2,000.00) FOR EACH OFFENSE; PROVIDING FOR A SEVERABILITY CLAUSE; PROVIDING FOR A REPEALER CLAUSE; PROVIDING FOR AN EFFECTIVE DATE.

The motion passed by a vote of 7 ayes to 0 nays.

5. **Z2023-042** - Hold a public hearing to discuss and consider a request by Juan J. Vasquez of Vasquez Engineering, LLC on behalf of Shane Shoulders of Kennor Rockwall Retail, LLC for the approval of an ordinance for a Specific Use Permit (SUP) for a Restaurant, with 2,000 SF or More, with Drive-

Through or Drive-In on a 1.93-acre parcel of land identified as Lots 8 & 9, Block A, Dalton-Goliad Addition, City of Rockwall, Rockwall County, Texas, zoned General Retail (GR) District, situated within the North SH-205 Overlay (N. SH-205 OV) District, addressed as 3611 & 3775 N. Goliad Street [SH-205], and take any action necessary **(1st Reading)**.

Planning Director, Ryan Miller provided background information on this agenda item. In 2017 Council approved an SUP that would allow a restaurant greater than 2k square feet with a drive-through or drive-in, and it was anticipated to be a Freddy's Frozen Custard; however, the restaurant was never constructed, and the site plan and SUP from then expired. Thereafter, in 2020, Council approved a conveyance plat that subdivided one lot into four. Then in 2021, Council denied an SUP request associated with a proposed Self-Service Car Wash on the property. At this time the applicant has submitted an application and concept plan, depicting the layout of two (2) Retail Building that are 6,300 SF and 6,065 SF. The 6,300 SF Retail Building will include a Restaurant with a Drive-through. The proposed restaurant will consist of a single drive-through lane. The concept plan shows that there will be 70 parking spaces provided for the proposed development. The concept plan also shows that the drive-through will be oriented so that the exit will be facing onto N. Goliad Street. Based on this, staff is requesting that the applicant provide additional landscape screening adjacent to drive-through lane and along N. Goliad Street [SH-205] to impair the visibility and impact of head-lights from motor vehicles in the drive-through lane on adjacent properties and rights-of-way. In addition, there is residential adjacency to the north, where the applicant has provided the required 20-foot landscape buffer. Staff should note that the additional landscaping has been included in the draft ordinance as operational conditions should the Specific Use Permit (SUP) be approved. In this case, the submitted concept plan appears to meet the Conditional Land Use Standards outlined within the UDC. Staff has included an operational condition within the draft ordinance that requires additional landscaping be provided adjacent to the drive through lane, N. Goliad Street, and in the northwestern corner of the site to impair the potential impacts of the proposed land use. Staff should note that a full site plan submittal including building elevations and a landscape plan will need to be reviewed by the Architectural Review Board (ARB) and Planning and Zoning Commission at the time of site plan. On August 22, 2023, staff mailed 44 notices to property owners and residents within 500-feet of the subject property. Staff also notified the Castle Ridge, Harlan Park, Stone Creek and Rockwall Shores Homeowner's Association (HOA), which are the only Homeowner's Associations (HOA's)/Neighborhood Organizations within 1,500-feet of the subject property participating in the Neighborhood Notification Program. Additionally, staff posted a sign on the subject property, and advertised the public hearings in the Rockwall Herald Banner as required by the Unified Development Code (UDC). Two notices were received back in opposition of the applicant's request. In addition, on September 12, 2023, the Planning and Zoning Commission approved a motion to recommend approval of the SUP by a vote of 6-0 with Commissioner Womble absent.

Mayor Johannesen opened the public hearing, asking if anyone would like to come forth and speak. There being no one indicating such, he then closed the public hearing.

The applicant then came forth and answered questions of Council.

Juan Vasquez
Vasquez Engineering
1919 South Shiloh Road
Garland, TX 75042

In response to inquiries from Councilmember Jorif, Mr. Vasquez expressed that, at this time, the developer does not have any particular restaurant established; however, he does know it will not end up being any of the major ones such as a Freddy's, Burger King, or McDonald's. Instead, the tenant will likely end up being a more local type place such as a sandwich, pizza place, or coffee shop; however, the developer does not have

a tenant or lease in place with anyone at this time.

Following additional clarification by Mr. Vasquez at the request of Councilmember Jorif, Councilmember Moeller then moved to approve Z2023-042. Councilmember Lewis seconded the motion. The ordinance caption was read as follows:

CITY OF ROCKWALL
ORDINANCE NO. 23-XX
SPECIFIC USE PERMIT NO. S-XXX

AN ORDINANCE OF THE CITY COUNCIL OF THE CITY OF ROCKWALL, TEXAS, AMENDING THE UNIFIED DEVELOPMENT CODE [ORDINANCE NO. 20-02] OF THE CITY OF ROCKWALL, TEXAS, AS PREVIOUSLY AMENDED, SO AS TO GRANT A SPECIFIC USE PERMIT (SUP) TO ALLOW A RESTAURANT, WITH 2,000 SF OR MORE WITH A DRIVE-THROUGH OR DRIVE-IN ON A 1.93-ACRE PARCEL OF LAND IDENTIFIED AS LOTS 8 & 9, BLOCK A, DALTON-GOLIAD ADDITION, CITY OF ROCKWALL, ROCKWALL COUNTY, TEXAS; PROVIDING FOR SPECIAL CONDITIONS; PROVIDING FOR A PENALTY OR FINE NOT TO EXCEED THE SUM OF TWO THOUSAND DOLLARS (\$2,000.00) FOR EACH OFFENSE; PROVIDING FOR A SEVERABILITY CLAUSE; PROVIDING FOR A REPEALER CLAUSE; PROVIDING FOR AN EFFECTIVE DATE.

The motion passed by a vote of 7 ayes to 0 nays.

6. **Z2023-043** - Hold a public hearing to discuss and consider a request by Angelina Nguyen for the approval of an ordinance for a *Specific Use Permit (SUP)* for *Residential Infill In an Established Subdivision* on a 0.16-acre parcel of land identified as Lot 18, Block B, Harbor Landing, Phase 2 Addition, City of Rockwall, Rockwall County, Texas, zoned Planned Development District 8 (PD-8), addressed as 303 Harborview Drive, and take any action necessary (**1st Reading**).

Planning Director, Ryan Miller provided background information on this agenda item. This applicant is seeking approval of an SUP in order to construct a two-story single-family home that is 3,990 square feet. This is within an established subdivision, and Council is being asked to consider the size, location and architecture of the proposed home as compared to nearby, existing homes. In this instance, the proposed home does not conform to two standards outlined in the city's Unified Development Code (UDC) – (1) the garage orientation and (2) the roof pitch. The applicant would like a front-facing garage that projects in front of the front façade of the home (instead of having it set back, as required). Also, the applicant is requesting a flat, metal roof. On August 22, 2023, staff mailed 53 notices to property owners and occupants within 500-feet of the subject property. Staff also sent a notice to the Chandler's Landing, The Cabana at Chandler's Landing, Match Point Townhomes, Cutter Hill Phase 1, Cutter Hill Phase 2, Cutter Hill Phase 3, Spyglass Phases 2 & 3, and Spyglass Phase 1 Homeowner's Associations (HOAs). Staff received an email from the Chandler's Landing Architectural Control Committee, stating that they do not allow a flat roof and expressing some concerns about deed restrictions. Staff conveyed those concerns to the applicant and included that letter in the information provided to Council in the meeting packet. Staff did not receive any public notices returned, neither in favor nor against the request. In addition, on September 12, 2023, the Planning and Zoning Commission approved a motion to recommend approval of the SUP by a vote of 6-0 with Commissioner Womble absent.

Mayor Johannesen opened the public hearing, asking if anyone would like to come forth and speak. There being no one indicating such, he then closed the public hearing. Councilmember Lewis pointed out there are no flat roofs in the area, but it will have to have some sort of slope in order for water to drain off the roof.

Mr. Miller shared that, yes, some degree of slope would need to be in place. Councilmember Lewis pointed out that there was a previous lawsuit from back in the 1990's that established how high structures can be in the Chandler's Subdivision.

Councilmember Lewis moved to approve Z2023-041. Mayor Pro Tem Campbell seconded the motion. The ordinance caption was read as follows:

**CITY OF ROCKWALL
ORDINANCE NO. 23-XX
SPECIFIC USE PERMIT NO. S-2XX**

AN ORDINANCE OF THE CITY COUNCIL OF THE CITY OF ROCKWALL, TEXAS, AMENDING PLANNED DEVELOPMENT DISTRICT 8 (PD-8) [ORDINANCE NO. 23-40] AND THE UNIFIED DEVELOPMENT CODE (UDC) [ORDINANCE NO. 20-02] OF THE CITY OF ROCKWALL, ROCKWALL COUNTY, TEXAS, AS PREVIOUSLY AMENDED, SO AS TO GRANT A SPECIFIC USE PERMIT (SUP) FOR *RESIDENTIAL INFILL IN AN ESTABLISHED SUBDIVISION* TO ALLOW THE CONSTRUCTION OF A SINGLE-FAMILY HOME ON A 0.1519-ACRE PARCEL OF LAND, IDENTIFIED AS LOT 18, BLOCK B, OF THE HARBOR LANDING PHASE 2 ADDITION, CITY OF ROCKWALL, ROCKWALL COUNTY, TEXAS; AND MORE SPECIFICALLY DESCRIBED AND DEPICTED IN *EXHIBIT 'A'* OF THIS ORDINANCE; PROVIDING FOR SPECIAL CONDITIONS; PROVIDING FOR A PENALTY OF FINE NOT TO EXCEED THE SUM OF TWO THOUSAND DOLLARS (\$2,000.00) FOR EACH OFFENSE; PROVIDING FOR A SEVERABILITY CLAUSE; PROVIDING FOR A REPEALER CLAUSE; PROVIDING FOR AN EFFECTIVE DATE.

The motion to approve passed by a vote of 7 ayes to 0 nays.

XII. Action Items

1. Discuss and consider approval of an **ordinance** establishing the Rockwall Municipal Court as a Court of Record, and take any action necessary (**1st reading**).

City Manager, Mary Smith provided background information concerning this agenda item, generally indicating that Councilmembers McCallum and Jorif previously asked staff to research the possibility of establishing the city's Municipal Court as a 'court of record.' Councilmember McCallum provided several comments, speaking briefly on the reasons why making our court a "court of record" would be advisable, what the costs would be (minimal, he indicated), and comparing the anticipated costs to other neighboring courts, such as in Royse City and Fate. He briefly drew additional comparisons between our municipal court and Royse City's, which has been a 'court of record' for the last fourteen years. He explained that our city's Municipal Court Judge is in favor of establishing ours as a 'court of record.' He went on to generally indicate he would like to see the Council move forward with adopting this ordinance. He believes that any potential increase in staff workload would be minimal if the city's court does become a 'court of record.'

Councilmember Jorif shared that, from a law enforcement perspective, becoming a 'court of record' gives the city more enforcement oversight, especially related to appeals.

Mayor Pro Tem Campbell clarified the differences between a non 'court of record' versus a 'court of record.' She pointed out that both our existing (non-'court of record') court and a 'court of record' are legitimate

courts.

Councilmember McCallum moved to approve this ordinance. Councilmember Jorif seconded the motion, which passed unanimously.

2. Discuss and consider approval of the Rockwall Economic Development Corporation (REDC) budget for fiscal year 2024 and amended budget for fiscal year 2023, as well as the 'Annual Work Plan' for FY2024, and take any action necessary

Phil Wagner, current President and CEO of the REDC, then briefly came forth, pointing out that details concerning the REDC's accomplishments over the course of this fiscal year as well as a proposed "Work Plan" for the upcoming fiscal year have been provided to Council for review.

Councilmember Jorif moved to approve both the amended budget for FY2023 and the proposed budget for FY2024 for the REDC as well as the REDC annual Work Plan for 2024. Councilmember Lewis seconded the motion, which passed unanimously of those present (7 ayes to 0 nays).

3. Discuss and consider approval of the Rockwall Technology Park Association budget for fiscal year 2024 and amended budget for fiscal year 2023, and take any action necessary.

Phil Wagner, President and CEO of the REDC was present to provide comments or answer questions; however none were asked. Councilmember McCallum then moved to approve both the amended budget for FY2023 and the proposed budget for FY2024 for the Rockwall Tech Park. Councilmember Lewis seconded the motion, which passed unanimously of those present (7 ayes to 0 nays).

4. Discuss and consider approval of an **ordinance** amending the budget for fiscal year 2023, and take any action necessary.

Councilmember Lewis moved to approve the ordinance amending the budget. Councilmember Jorif seconded the motion. The caption was read as follows:

**CITY OF ROCKWALL, TEXAS
ORDINANCE NO. 23-50**

AN ORDINANCE OF THE CITY COUNCIL OF THE CITY OF ROCKWALL, TEXAS, AMENDING THE BUDGET OF THE CITY FOR THE FISCAL YEAR OCTOBER 1, 2022 THROUGH SEPTEMBER 30, 2023; PROVIDING FOR AN EFFECTIVE DATE.

The motion passed by a vote of 7 ayes to 0 nays.

5. Discuss and consider approval of an **ordinance** adopting the proposed budget for fiscal year 2024, and take any action necessary.

Councilmember Lewis moved to approve the ordinance. Councilmember McCallum seconded the motion. The ordinance caption was read as follows:

**CITY OF ROCKWALL
ORDINANCE NO. 23-51**

AN ORDINANCE OF THE CITY COUNCIL OF THE CITY OF ROCKWALL, TEXAS, APPROVING AND ADOPTING A BUDGET FOR THE CITY FOR THE FISCAL YEAR OCTOBER 1, 2023, THROUGH SEPTEMBER 30, 2024; PROVIDING THAT EXPENDITURES FOR SAID FISCAL YEAR SHALL BE MADE IN ACCORDANCE WITH THE SAID BUDGET; AND PROVIDING FOR AN EFFECTIVE DATE.

The motion passed by a vote of 7 ayes to 0 nays.

6. Discuss and consider approval of an ordinance levying ad valorem taxes for the tax year 2023, and take any action necessary.

Mayor Pro Tem Campbell moved to approve the ordinance, which set the tax rate at 27.0245 cents per one hundred dollars of assessed value. Councilmember Jorif seconded the motion. The ordinance caption was read as follows:

**CITY OF ROCKWALL, TEXAS
ORDINANCE NO. 23-52**

AN ORDINANCE OF THE CITY COUNCIL OF THE CITY OF ROCKWALL, TEXAS, LEVYING THE AD VALOREM TAXES FOR THE YEAR 2023 AT A RATE OF \$.270245 PER ONE HUNDRED DOLLARS (\$100.00) ASSESSED VALUATION ON ALL TAXABLE PROPERTY WITHIN THE CORPORATE LIMITS OF THE CITY AS OF JANUARY 1, 2023 TO PROVIDE REVENUES FOR THE PAYMENT OF CURRENT EXPENSES AND TO PROVIDE AN INTEREST AND SINKING FUND ON ALL OUTSTANDING DEBTS OF THE CITY; PROVIDING FOR DUE AND DELINQUENT DATES, TOGETHER WITH PENALTIES AND INTEREST; APPROVING THE 2023 TAX ROLL; PROVIDING FOR EXEMPTIONS OF PERSONS OVER SIXTY-FIVE (65) YEARS; PROVIDING AN EFFECTIVE DATE.

The motion passed unanimously of those present (7 ayes to 0 nays).

7. Discuss and consider the Hotel Tax Subcommittee recommendations for funding allocations in fiscal year 2024, including authorizing the City Manager to execute associated funding arrangements, and take any action necessary.

Councilmember McCallum made a motion to approve the funding recommendations of the HOT subcommittee, excluding the requests for Meals on Wheels and Helping Hands. Councilmember Thomas seconded the motion, which passed unanimously of those present (7 ayes to 0 nays).

Councilmember Jorif moved to approve the funding request for Meals on Wheels. Councilmember McCallum seconded the motion, which passed by a vote of 6 ayes with 1 abstention (Lewis).

Councilmember McCallum moved to approve the recommended funding for Helping Hands. Mayor Pro Tem Campbell seconded the motion, which passed by a vote of 6 ayes with 1 abstention (Thomas).

XIII. Adjournment

Mayor Johannesen adjourned the public meeting at 7:44 p.m.

PASSED AND APPROVED BY THE CITY COUNCIL OF THE CITY OF ROCKWALL, TEXAS ON THIS 2nd DAY OF OCTOBER, 2023.

TRACE JOHANNESSEN, MAYOR

ATTEST:

KRISTY TEAGUE, CITY SECRETARY

CITY OF ROCKWALL

ORDINANCE NO. 23-53

AN ORDINANCE OF THE CITY COUNCIL OF THE CITY OF ROCKWALL, TEXAS, AMENDING PLANNED DEVELOPMENT DISTRICT 3 (PD-3) AND THE UNIFIED DEVELOPMENT CODE [ORDINANCE NO. 20-02] OF THE CITY OF ROCKWALL, AS HERETOFORE AMENDED, SO AS TO CONSOLIDATE THE REGULATING ORDINANCES OF THE PLANNED DEVELOPMENT DISTRICT, BEING A 639.264-ACRE TRACT OF LAND SITUATED WITHIN THE T. DEAN SURVEY, ABSTRACT NO. 69; S. KING SURVEY, ABSTRACT NO. 131; N. BUTLER SURVEY, ABSTRACT NO. 21; AND, A. HANNA SURVEY, ABSTRACT NO. 98, CITY OF ROCKWALL, ROCKWALL COUNTY, TEXAS AND MORE FULLY DESCRIBED HEREIN BY EXHIBIT 'A' AND DEPICTED HEREIN BY EXHIBIT 'B'; PROVIDING FOR SPECIAL CONDITIONS; PROVIDING FOR A PENALTY OF FINE NOT TO EXCEED THE SUM OF TWO THOUSAND DOLLARS (\$2,000.00) FOR EACH OFFENSE; PROVIDING FOR A SEVERABILITY CLAUSE; PROVIDING FOR A REPEALER CLAUSE; PROVIDING FOR AN EFFECTIVE DATE.

WHEREAS, the City of Rockwall has initiated an amendment to the Planned Development District 3 (PD-3) for the purpose of consolidating the regulating ordinances [*Ordinance No.'s 72-02, 77-19A, 80-33, 84-59, 86-23, 86-39, 86-61, 89-04, 94-35, & 96-23*].

WHEREAS, Planned Development District 3 (PD-3) is a 639.264-acre tract of land situated within the T. Dean Survey, Abstract No. 69; S. King Survey, Abstract No. 131; N. Butler Survey, Abstract No. 21; and, A. Hanna Survey, Abstract No. 98, City of Rockwall, Rockwall County, Texas and which is more fully described in *Exhibit 'A'* of this ordinance, which hereinafter shall be referred to as the *Subject Property* and incorporated by reference herein; and

WHEREAS, the Planning and Zoning Commission of the City of Rockwall and the governing body of the City of Rockwall in compliance with the laws of the State of Texas and the ordinances of the City of Rockwall have given the requisite notices by publication and otherwise, and have held public hearings and afforded a full and fair hearing to all property owners generally and to all persons interested in and situated in the affected area, and in the vicinity thereof, and the governing body in the exercise of its legislative discretion, has concluded that Planned Development District 3 (PD-3) [*Ordinance No.'s 72-02, 77-19A, 80-33, 84-59, 86-23, 86-39, 86-61, 89-04, 94-35, 96-23 & 11-44*] and the Unified Development Code [*Ordinance No. 20-02*] should be amended as follows:

NOW, THEREFORE, BE IT ORDAINED BY THE CITY COUNCIL OF THE CITY OF ROCKWALL, TEXAS:

SECTION 1. That the approval of this ordinance shall supersede all requirements stipulated in *Ordinance No.'s 72-02, 77-19A, 80-33, 84-59, 86-23, 86-39, 86-61, 89-04, 94-35, & 96-23*;

SECTION 2. That the *Subject Property* shall be used only in the manner and for the purposes authorized by this Planned Development District Ordinance and the Unified Development Code [*Ordinance No. 20-02*] of the City of Rockwall as heretofore amended, as amended herein by granting this zoning change, and as maybe amended in the future;

SECTION 3. That development of the *Subject Property* shall generally be in accordance with the *Concept Plan*, depicted in *Exhibit 'C'* of this ordinance, attached hereto and incorporated

herein by reference as *Exhibit 'C'*, which is deemed hereby to be a condition of approval of the amended zoning classification for the *Subject Property*;

SECTION 4. That development of the *Subject Property* shall generally be in accordance with the *Density and Development Standards*, outlined in *Exhibit 'D'* of this ordinance, attached hereto and incorporated herein by reference as *Exhibit 'D'*, which is deemed hereby to be a condition of approval of the amended zoning classification for the *Subject Property*;

SECTION 5. The Homeowner's Association (HOA) shall be responsible for the maintenance of all common areas, screening walls and features, landscape areas, deed restriction enforcement, and all other functions required to maintain the quality of the development.

SECTION 6. That any person, firm, or corporation violating any of the provisions of this ordinance shall be deemed guilty of a misdemeanor and upon conviction shall be punished by a penalty of fine not to exceed the sum of *Two Thousand Dollars* (\$2,000.00) for each offense and each and every day such offense shall continue shall be deemed to constitute a separate offense;

SECTION 7. That if any section, paragraph, or provision of this ordinance or the application of that section, paragraph, or provision to any person, firm, corporation or situation is for any reason judged invalid, the adjudication shall not affect any other section, paragraph, or provision of this ordinance or the application of any other section, paragraph or provision to any other person, firm, corporation or situation, nor shall adjudication affect any other section, paragraph, or provision of the Unified Development Code, and the City Council declares that it would have adopted the valid portions and applications of the ordinance without the invalid parts and to this end the provisions for this ordinance are declared to be severable;

SECTION 8. The standards in this ordinance shall control in the event of a conflict between this ordinance and any provision of the Unified Development Code or any provision of the City Code, ordinance, resolution, rule, regulation, or procedure that provides a specific standard that is different from and inconsistent with this ordinance. References to zoning district regulations or other standards in the Unified Development Code (including references to the *Unified Development Code*), and references to overlay districts, in this ordinance or any of the Exhibits hereto are those in effect on the date this ordinance was passed and approved by the City Council of the City of Rockwall, Texas;

SECTION 9. That this ordinance shall take effect immediately from and after its passage;

PASSED AND APPROVED BY THE CITY COUNCIL OF THE CITY OF ROCKWALL, TEXAS, THIS THE 2ND DAY OF OCTOBER, 2023.

Trace Johannesen, Mayor

ATTEST:

Kristy Teague, City Secretary

APPROVED AS TO FORM:

Frank J. Garza, City Attorney

1st Reading: September 18, 2023

2nd Reading: October 2, 2023

Exhibit 'A':
Legal Description

BEING 639.264 acres of land situated in Abstract 69, T. Dean Survey; Abstract 131, S. King Survey; Abstract 21, N. Butler Survey; and Abstract 98, A. Hanna Survey in the County of Rockwall, Texas and being more particularly described by metes and bounds as follows:

COMMENCING at a point in the North Right of Way of North Lakeshore Dr. at the City of Rockwall Geodetic Control Monument #13. (NAD83 Texas State Plane GPS Coordinate (Grid): E 2,590,432.919, N 7,032,885.954 Feet) bearing North 10°-01'-31" East, a distance of 4,838.978 feet to the POINT OF BEGINNING;

BEGINNING at a Southwestern corner of Abstract 71, W. T. Deweese Survey, Tract 5, also known as 3051 North Goliad Street, (NAD83 Texas State Plane GPS Coordinate (Grid): E 2,591,205.473, N 7,037,644.958 Feet);

- 1 **THENCE** South 88°-09'-30" East, a distance of 174.421 feet to a point;
- 2 **THENCE** South 89°-18'-00" East, along the Northern boundary of the Creekside Village Phase 2 Addition, a distance of 807.443 feet to a point;
- 3 **THENCE** North 89°-50'-27" East, a distance of 574.25 feet to a point in the Right of Way of State Highway 205 (North Goliad Street) also being a beginning of a curve;
- 4 **THENCE** along said curve to the left having an angle of 07°-09'-14" and a radius of 8,822.954 feet with a chord distance of 1,100.909 feet and a chord bearing of South 11°-10'-59" East, for a corner;
- 5 **THENCE** South 78°-44'-38" West, along the Southeastern boundary of the Random Oaks Addition, a distance of 131.806 feet to a point;
- 6 **THENCE** South 77°-32'-26" West, continuing along said boundary a distance of 104.85 feet for a corner;
- 7 **THENCE** South 02°-01'-44" West, a distance of 199.631 feet to a point;
- 8 **THENCE** South 03°-01'-38" West, a distance of 549.228 feet to a point;
- 9 **THENCE** South 09°-42'-57" East, a distance of 234.514 for a corner;
- 10 **THENCE** North 80°-11'-17" West, along the Southern boundary of the Random Oaks Addition, a distance of 730.471 feet to a point;
- 11 **THENCE** North 82°-37'-24" West, a distance of 185.747 feet to the beginning of a curve;
- 12 **THENCE** along said curve to the left having an angle of 04°-07'-30" and a radius of 2,056.937 feet with a chord distance of 148.058 feet and a chord bearing of North 84°-08'-37" West, to the beginning of a reverse curve;
- 13 **THENCE** along said curve to the right having an angle of 19°-31'-59" and a radius of 513.44 feet with a chord distance of 174.193 feet and a chord bearing of North 72°-20'-57" West, a point;
- 14 **THENCE** North 62°-41'-51" West, a distance of 96.467 feet to a point;
- 15 **THENCE** North 23°-56'-24" East, a distance of 10.376 feet to the beginning of a curve;
- 16 **THENCE** along said curve to the right having an angle of 04°-10'-41" and a radius of 4,343.413 feet with a chord distance of 316.73 feet and a chord bearing of North 62°-52'-52" West, to the beginning of a curve;
- 17 **THENCE** along said curve to the right having an angle of 00°-26'-05" and a radius of 32,477.593 feet with a chord distance of 246.45 feet and a chord bearing of North 54°-34'-4" West, to the beginning of a curve;
- 18 **THENCE** along said curve to the left having an angle of 06°-44'-13" and a radius of 5,575.459 feet with a chord distance of 655.568 feet and a chord bearing of North 79°-07'-52" West, a point;
- 19 **THENCE** North 87°-52'-21" West, a distance of 39.207 feet for a corner;
- 20 **THENCE** South 00°-40'-53" East, along the Eastern boundary of The Shores Addition, a distance of 342.584 feet to a point;
- 21 **THENCE** South 00°-59'-46" West, a distance of 254.457 feet to a point;
- 22 **THENCE** South 00°-03'-57" West, a distance of 9.989 feet for a corner;
- 23 **THENCE** South 45°-28'-05" West, a distance of 202.51 feet for a corner;
- 24 **THENCE** South 04°-46'-24" West, a distance of 519.313 feet for a corner;
- 25 **THENCE** North 89°-44'-36" East, a distance of 96.721 feet for a corner;
- 26 **THENCE** South 01°-21'-55" East, along the Eastern boundary of The Shores Phase 3 Addition, a distance of 433.694 feet to a point;
- 27 **THENCE** South 00°-53'-02" West, a distance of 1,723.961 feet to a point;

Exhibit 'A':
Legal Description

- 28 **THENCE** South 82°-27'-37" West, a distance of 6.603 feet for a corner;
- 29 **THENCE** South 01°-15'-03" West, a distance of 121.92 feet to a point;
- 30 **THENCE** South 42°-45'-29" East, a distance of 55.379 feet to a point;
- 31 **THENCE** South 60°-28'-27" East, a distance of 110.47 feet to a point;
- 32 **THENCE** South 88°-22'-52" East, a distance of 229.342 feet for a corner;
- 33 **THENCE** South 00°-56'-40" West, continue around the area known as the Blase Family Farm, a distance of 800.823 feet for a corner;
- 34 **THENCE** North 89°-08'-02" West, a distance of 100.012 feet for a corner;
- 35 **THENCE** South 00°-51'-58" West, a distance of 120.015 feet for a corner;
- 36 **THENCE** South 89°-08'-02" East, a distance of 100.012 feet for a corner;
- 37 **THENCE** South 00°-51'-58" West, a distance of 108.014 feet to a point;
- 38 **THENCE** South 00°-51'-58" West, continuing a distance of 45.768 feet to a point in the Right of Way of East Fork Road for a corner;
- 39 **THENCE** North 63°-36'-29" West, a distance of 141.47 feet to a point;
- 40 **THENCE** North 61°-55'-58" West, a distance of 245.277 feet to a point;
- 41 **THENCE** North 55°-50'-09" West, a distance of 465.358 feet to a point;
- 42 **THENCE** North 42°-26'-08" West, a distance of 88.961 feet for a corner;
- 43 **THENCE** North 46°-41'-33" East, a distance of 148.35 feet to a point;
- 44 **THENCE** North 14°-28'-50" East, a distance of 186.703 feet for a corner;
- 45 **THENCE** North 89°-15'-27" West, a distance of 436.763 feet to a point;
- 46 **THENCE** North 74°-56'-00" West, crossing North Lakeshore Drive, a distance of 83.869 feet to a point;
- 47 **THENCE** North 89°-25'-39" West, along the Southern boundary of the Crestview Phase 1 Addition, a distance of 737.795 feet for a corner;
- 48 **THENCE** North 01°-10'-48" West, a distance of 312.433 feet for a corner;
- 49 **THENCE** North 89°-14'-21" West, a distance of 503.944 feet for a corner;
- 50 **THENCE** South 00°-23'-22" East, a distance of 318.21 feet for a corner;
- 51 **THENCE** North 89°-19'-25" West, along the Southern boundary of the Crestview Phase 3 Addition, a distance of 181.831 feet to a point;
- 52 **THENCE** South 80°-24'-05" West, a distance of 15.253 feet to a point;
- 53 **THENCE** North 89°-47'-20" West, a distance of 565.495 feet to a point;
- 54 **THENCE** North 73°-29'-07" West, a distance of 15.698 feet to a point;
- 55 **THENCE** South 87°-34'-56" West, a distance of 80.08 feet to a point;
- 56 **THENCE** North 89°-30'-59" West, a distance of 570.754 feet for a corner;
- 57 **THENCE** South 00°-12'-51" West, a distance of 15.459 feet for a corner;
- 58 **THENCE** North 89°-46'-14" West, a distance of 309.468 feet to a point;
- 59 **THENCE** South 89°-34'-27" West, a distance of 296.789 for a corner;
- 60 **THENCE** North 06°-17'-47" East, along the City of Dallas Take Line of Lake Ray Hubbard and adjacent residential lots, a distance of 2.096 feet to a point;
- 61 **THENCE** North 27°-55'-11" West, continuing along said Take Line, a distance of 322.756 feet to a point;
- 62 **THENCE** North 28°-28'-37" West, a distance of 276.945 feet to a point;
- 63 **THENCE** North 21°-37'-19" West, a distance of 678.581 feet to a point;
- 64 **THENCE** North 05°-55'-34" West, a distance of 449.668 feet to a point;
- 65 **THENCE** North 17°-42'-55" East, a distance of 980.368 feet to a point;
- 66 **THENCE** North 19°-36'-38" East, a distance of 21.013 feet to a point;
- 67 **THENCE** North 53°-26'-39" East, crossing the Rockwall Golf and Athletic Club Golf Course, a distance of 679.516 feet to a point;
- 68 **THENCE** South 84°-07'-20" East, a distance of 603.751 feet to a point;
- 69 **THENCE** South 71°-02'-28" East, a distance of 770.226 feet to a point;
- 70 **THENCE** South 88°-36'-41" East, a distance of 445.095 feet for a corner;
- 71 **THENCE** North 01°-07'-35" East, along the Western boundary of The Shores Addition, a distance of 1,687.816 feet to a point;
- 72 **THENCE** North 01°-41'-23" East, a distance of 195.033 feet to a point;
- 73 **THENCE** North 00°-17'-09" East, a distance of 60.183 feet to a point;
- 74 **THENCE** North 12°-28'-00" West, a distance of 165.262 feet to a point;

Exhibit 'A':
Legal Description

- 75 **THENCE** North 13°-24'-39" West, a distance of 112.025 feet to a point;
- 76 **THENCE** North 02°-20'-39" East, a distance of 330.71 feet to the beginning of a curve;
- 77 **THENCE** along said point being the beginning of a curve to the left having an angle of 05°-05'-40" and a radius of 1,829.031 feet with a chord distance of 162.577 feet and a chord bearing of North 11°-21'-39" East, a point;
- 78 **THENCE** North 10°-06'-17" East, a distance of 190.56 feet to a point;
- 79 **THENCE** North 00°-43'-21" East, a distance of 737.697 feet for a corner;
- 80 **THENCE** North 89°-55'-30" East, along the Northern boundary of the Shores Phase 4B Addition, a distance of 644.247 feet to a point;
- 81 **THENCE** North 89°-42'-06" East, along the Northern boundary of the City of Rockwall Shores Park, a distance of 1,060.108 feet for a corner;
- 82 **THENCE** North 00°-46'-08" East, a distance of 223.527 feet to a point;
- 83 **THENCE** North 03°-16'-35" East, a distance of 50.034 feet to a point;
- 84 **THENCE** North 00°-24'-45" East, along the Western boundary of the Shores Phase 5 Addition, a distance of 443.593 feet to a point;
- 85 **THENCE** North 01°-29'-10" West, continuing along said boundary, a distance of 65.666 feet to a point;
- 86 **THENCE** North 00°-37'-36" East, a distance of 900.321 feet to a point;
- 87 **THENCE** North 03°-37'-13" East, to a point in the Right of Way of Dalton Road, a distance of 16.021 feet for a corner;
- 88 **THENCE** South 89°-40'-13" East, a distance of 1,314.588 feet for a corner;
- 89 **THENCE** South 00°-32'-35" West, a distance of 26.441 feet to a point;
- 90 **THENCE** South 00°-32'-35" West, continuing along the Eastern boundary of the Shores North Phase 6 Addition, a distance of 1,143.321 feet to a point;
- 91 **THENCE** South 00°-28'-51" West, continuing along said boundary, a distance of 1,453.759 feet, to the **POINT OF BEGINNING AND CONTAINING** 639.264 acres of land (27,846,211.88 square feet) more or less.

Exhibit 'B':
Survey



Exhibit 'D':
Density and Development Standards

(1) NON-RESIDENTIAL.

(A) TRACT 1. (Unplatted)

(1) Permitted Land Uses. Unless specifically provided by this Planned Development District ordinance, *Tract 1 -- as depicted in Exhibit 'C' of this ordinance* -- shall be subject to the land uses permitted within the Commercial (C) District, as stipulated by the *Permissible Use Charts* contained in Article 04, *Permissible Uses*, of the Unified Development Code (UDC), as heretofore amended, as amended herein by granting this zoning change, and as maybe amended in the future.

(2) Density and Development Standards. The development of *Tract 1 -- as depicted in Exhibit 'C' of this ordinance* -- shall be subject to the density and dimensional standards stipulated for properties in a Commercial (C) District as required by Subsection 04.05, *Commercial (C) District*, of Article 05, *District Development Standards*, of the Unified Development Code [*Ordinance No. 20-02*] of the City of Rockwall as heretofore amended, as amended herein by granting this zoning change, and as maybe amended in the future.

(B) TRACT 2. (The Shops at Ridge Creek Subdivision)

(1) Permitted Land Uses. Unless specifically provided by this Planned Development District ordinance, *Tract 2 -- as depicted in Exhibit 'C' of this ordinance* -- shall be subject to the land uses permitted within the General (GR) District, as stipulated by the *Permissible Use Charts* contained in Article 04, *Permissible Uses*, of the Unified Development Code (UDC), as heretofore amended, as amended herein by granting this zoning change, and as maybe amended in the future; however, the following amendments shall apply to *Tract 2*:

(A) The following land uses shall be permitted *by-right*:

- Any retail business, personal services, professional services, or business service conducted within a completely enclosed building, except the following: [1] lumber yards, [2] contractor yards, [3] farm equipment, [4] heavy equipment sales or service, [5] farm products warehousing or storage, [6] stockyards, and/or [7] general warehousing or storage.
- Banks (*with or without drive-through facilities*).
- Planned Shopping Centers of less than ten (10) acres and neighborhood convenience centers.
- Office Buildings.
- Paved Parking Lots (*not including commercial parking lots*).
- Other uses similar to the above.
- Telephone, telegraph, television, radio or similar media stations, centers, studios, but not including public microwave, radio, and television towers.
- Institutional Uses.
- Municipally owned or controlled facilities, utilities, and uses.
- Restaurants, including accessory outdoor seating, without drive-in or drive-through facilities.
- Retail outlets where gasoline products are sold as an accessory use limited to two (2) dispensers which can service no more than four (4) vehicles at a time.
- An accessory use customarily related to a principal use authorized in this zoning district.
- Temporary indoor and outdoor fund-raising events sponsored by nonprofit organizations with permit and approval from the Building Official.
- Temporary on-site construction offices limited to the period of construction upon approval of the Building Official.

Exhibit 'D':
Density and Development Standards

(B) The following land uses shall be permitted by Specific Use Permit (SUP):

- A mobile home on an un-subdivided tract of five (5) acres or more used as a construction office.
- Automotive repair, as an accessory to a retail use, provided all work is conducted wholly within a completely enclosed building.
- Funeral Homes.
- Non-Open Bay Carwash.
- Facilities for railroads or those utilities holding a franchise under the City of Rockwall not allowed as permitted uses.
- Semi-Public Uses.
- Commercial amusements, as defined herein, including amusements parks, circus or carnival grounds, recreation developments, or tents for amusements, in accordance with all other applicable ordinances, and more than 300-feet from residentially zoned land unless such setback is reduced or waived by the Planning and Zoning Commission and City Council. Temporary uses not exceeding 14-days meeting all other requirements of the City may be permitted by the Building Official.
- Drive-through window as an accessory to a restaurant.
- Private club as an accessory to a general restaurant.
- New buildings with over 5,000 SF of floor area, or additions of over 40% of existing floor area or over 5,000 SF with combustible structural construction materials.
- Buildings with less than 90% masonry exterior walls.
- Any structure over 36-feet in height.
- Veterinary clinics for treatment of small animals, with no outdoor pens or runs.
- Temporary concrete batching plant limited to the period of construction, upon approval of location and operation by the Building Official.

(2) *Density and Development Standards*. The development of *Tract 2 -- as depicted in Exhibit 'C' of this ordinance* -- shall be subject to the density and dimensional standards stipulated for properties in a General Retail (GR) District as required by Subsection 04.04, *General Retail (GR) District*, of Article 05, *District Development Standards*, of the Unified Development Code [*Ordinance No. 20-02*] of the City of Rockwall as heretofore amended, as amended herein by granting this zoning change, and as maybe amended in the future.

(C) *TRACT 3. (A portion of The Shores Club House Subdivision)*

(1) *Permitted Land Uses*. Unless specifically provided by this Planned Development District ordinance, *Tract 1 -- as depicted in Exhibit 'C' of this ordinance* -- shall be subject to the land uses permitted within the General Retail (GR) District, as stipulated by the *Permissible Use Charts* contained in Article 04, *Permissible Uses*, of the Unified Development Code (UDC), as heretofore amended, as amended herein by granting this zoning change, and as maybe amended in the future; however, only the following land uses shall be permitted within *Tract 3*:

(A) Community Center and Golf Course with pertinent accessory land uses (*i.e. swimming pool, restaurant, tennis courts, pickleball courts, pro-shop, etc.*)

(2) *Density and Development Standards*. The development of *Tract 1 -- as depicted in Exhibit 'C' of this ordinance* -- shall be subject to the density and dimensional standards stipulated for properties in a General Retail (GR) District as required by Subsection 04.04, *General Retail (GR) District*, of Article

Exhibit 'D':
Density and Development Standards

05, *District Development Standards*, of the Unified Development Code [Ordinance No. 20-02] of the City of Rockwall as heretofore amended, as amended herein by granting this zoning change, and as maybe amended in the future.

(2) RESIDENTIAL.

(A) TRACTS A, B, C, D, E, & F.

(1) Tracts. The tracts in this section correspond with the following phases of the Shores Subdivision:

- (A) Tract A. Hillside at the Shores, Phases 1-5 & a portion of Creekside Village, Phase 2.
- (B) Tract B. Crestview at the Shores, Phases 1-3.
- (C) Tract C. Creekside at the Shores.
- (D) Tract D. The Shores North, Phase 4B and portions of The Shores North, Phases 2A & 4A.
- (E) Tract E. The Shores North, Phases 3A, 3B, & 5.
- (F) Tract F. A portion of The Shores North, Phase 6.

(2) Permitted Land Uses. Unless specifically provided by this Planned Development District ordinance, *Tracts A, B, C, D, E, & F -- as depicted in Exhibit 'C' of this ordinance --* shall be subject to the land uses permitted within the Single-Family 7 (SF-7) District, as stipulated by the *Permissible Use Charts* contained in Article 04, *Permissible Uses*, of the Unified Development Code (UDC), as heretofore amended, as amended herein by granting this zoning change, and as maybe amended in the future.

(3) Density and Development Standards. The development of *Tracts A, B, C, D, E, & F -- as depicted in Exhibit 'C' of this ordinance --* shall be subject to the density and dimensional standards stipulated for properties in a Single-Family 7 (SF-7) District as required by Subsection 03.09, *Single-Family 7 (SF-7) District*, of Article 05, *District Development Standards*, of the Unified Development Code [Ordinance No. 20-02] of the City of Rockwall as heretofore amended, as amended herein by granting this zoning change, and as maybe amended in the future. In addition, all lots in *Tracts A, B, C, D, E, & F* shall conform to the standards depicted in *Table 1*, which are as follows:

TABLE 1: LOT DIMENSIONAL REQUIREMENTS

<i>Lot Type (see Concept Plan) ►</i>	A	B	C	D	E	F
<i>MINIMUM LOT AREA</i>	7,200 SF	6,000 SF	7,200 SF	7,200 SF	6,000 SF	7,200 SF
<i>AVERAGE LOT AREA FOR TRACT</i>	8,500 SF	7,200 SF	8,500 SF	8,000 SF	7,000 SF	10,000 SF
<i>SINGLE-FAMILY DWELLING UNITS PER LOT</i>	1	1	1	1	1	1
<i>MINIMUM FLOOR AREA PER DWELLING UNIT</i>	1,800 SF	1,500 SF	2,000 SF	1,800 SF	1,500 SF	1,600 SF
<i>MINIMUM LOT FRONTAGE ⁽¹⁾</i>	60'	50'	60'	60'	50'	60'
<i>MINIMUM LOT DEPTH</i>	100'	100'	100'	100'	100'	100'
<i>MINIMUM FRONT YARD SETBACK</i>	20'	20'	20'	20'	20'	20'
<i>MINIMUM REAR YARD SETBACK</i>	10'	10'	10'	10'	10'	10'
<i>MINIMUM SIDE YARD SETBACK</i>	5'	5'	5'	5'	5'	5'
<i>MINIMUM SIDE YARD SETBACK ADJACENT TO A STREET</i>	15'	15'	15'	15'	15'	15'
<i>MINIMUM BUILDING SEPERATION</i>	10'	10'	10'	10'	10'	10'
<i>MAXIMUM BUILDING COVERAGE</i>	45%	50%	45%	45%	50%	45%
<i>MAXIMUM BUILDING HEIGHT</i>	35'	35'	35'	35'	35'	35'
<i>MINIMUM OFF-STREET PARKING (SPACES/UNIT) ⁽²⁾</i>	2	2	2	2	2	2
<i>MINIMUM GARAGE SPACE (VEHICLES SPACES)</i>	2	2	2	2	2	2

GENERAL NOTES:

- ¹: Lot frontage shall be measured on a public street.
- ²: Excluding the required garage spaces.

Exhibit 'D':
Density and Development Standards

(B) TRACTS G, H, I, & J.

- (1) Tracts. The tracts in this section correspond with the following phases of the Shores Subdivision:
- (A) Tract G. Fairway Pointe at the Shores, Phases 1 & 2.
 - (B) Tract H. A portion of Creekside Village, Phase 2.
 - (C) Tract I. A portion of Creekside Village, Phase 2 and portions of The Shores North, Phases 2A, 2B, & 4A.
 - (D) Tract J. A portion of The Shores North, Phase 2A, 2B, & 4A.
- (2) Permitted Land Uses. Unless specifically provided by this Planned Development District ordinance, *Tracts G, H, I, & J -- as depicted in Exhibit 'C' of this ordinance* -- shall be subject to the land uses permitted within the Single-Family 10 (SF-10) District, as stipulated by the *Permissible Use Charts* contained in Article 04, *Permissible Uses*, of the Unified Development Code (UDC), as heretofore amended, as amended herein by granting this zoning change, and as maybe amended in the future.
- (3) Density and Development Standards. The development of *Tracts G, H, I, & J-- as depicted in Exhibit 'C' of this ordinance* -- shall be subject to the density and dimensional standards stipulated for properties in a Single-Family 10 (SF-10) District as required by Subsection 03.07, *Single-Family 10 (SF-10) District*, of Article 05, *District Development Standards*, of the Unified Development Code [Ordinance No. 20-02] of the City of Rockwall as heretofore amended, as amended herein by granting this zoning change, and as maybe amended in the future. In addition, all lots in *Tracts G, H, I, & J* shall conform to the standards depicted in *Table 2*, which are as follows:

TABLE 2: LOT DIMENSIONAL REQUIREMENTS

<i>Lot Type (see Concept Plan) ►</i>	G	H	I	J
<i>MINIMUM LOT AREA</i>	9,000 SF	9,000 SF	8,400 SF	9,000 SF
<i>AVERAGE LOT AREA FOR TRACT</i>	10,000 SF	N/A	N/A	N/A
<i>SINGLE-FAMILY DWELLING UNITS PER LOT</i>	1	1	1	1
<i>MINIMUM FLOOR AREA PER DWELLING UNIT</i>	2,200 SF	2,200 SF	2,000 SF	2,200 SF
<i>MINIMUM LOT FRONTAGE ⁽¹⁾</i>	70'	70'	60'	70'
<i>MINIMUM LOT DEPTH</i>	100'	100'	100'	100'
<i>MINIMUM FRONT YARD SETBACK</i>	20'	20'	20'	20'
<i>MINIMUM REAR YARD SETBACK</i>	10'	10'	10'	10'
<i>MINIMUM SIDE YARD SETBACK</i>	6'	6'	5'	5'
<i>MINIMUM SIDE YARD SETBACK ADJACENT TO A STREET</i>	15'	15'	15'	15'
<i>MINIMUM BUILDING SEPERATION</i>	10'	10'	10'	10'
<i>MAXIMUM BUILDING COVERAGE</i>	45%	45%	45%	45%
<i>MAXIMUM BUILDING HEIGHT</i>	35'	35'	35'	35'
<i>MINIMUM OFF-STREET PARKING (SPACES/UNIT) ⁽²⁾</i>	2	2	2	2
<i>MINIMUM GARAGE SPACE (VEHICLES SPACES)</i>	2	2	2	2

GENERAL NOTES:

- ¹: Lot frontage shall be measured on a public street.
- ²: Excluding the required garage spaces.

**Exhibit 'D':
Density and Development Standards**

(C) TRACT K. (Random Oaks at the Shores Subdivision)

(1) Concept Plan. All development of *Tract K* shall conform with the *Concept Plan* depicted in *Figure 1*.

FIGURE 1. CONCEPT PLAN FOR TRACT K



(2) Permitted Land Uses. Unless specifically provided by this Planned Development District ordinance, *Tract K* -- as depicted in Exhibit 'C' of this ordinance -- shall be subject to the land uses permitted within the Single-Family 10 (SF-10) District, as stipulated by the *Permissible Use Charts* contained in Article 04, *Permissible Uses*, of the Unified Development Code (UDC), as heretofore amended, as amended herein by granting this zoning change, and as maybe amended in the future.

(3) Density and Development Standards. The development of *Tract K* -- as depicted in Exhibit 'C' of this ordinance -- shall be subject to the density and dimensional standards stipulated for properties in a Single-Family 10 (SF-10) District as required by Subsection 03.07, *Single-Family 10 (SF-10) District*, of Article 05, *District Development Standards*, of the Unified Development Code [Ordinance No. 20-02] of the City of Rockwall as heretofore amended, as amended herein by granting this zoning change, and as maybe amended in the future. In addition, all lots in *Tract K* shall conform to the standards depicted in *Table 3*, which are as follows:

**Exhibit 'D':
Density and Development Standards**

TABLE 3: LOT DIMENSIONAL REQUIREMENTS

	Lot Type (see Concept Plan) ►	K
MINIMUM LOT AREA ⁽¹⁾		7,800 SF & 10,000 SF
MINIMUM FLOOR AREA PER DWELLING UNIT		1,800 SF
MINIMUM LOT FRONTAGE ⁽²⁾		100'
MINIMUM LOT DEPTH		60'
MINIMUM FRONT YARD SETBACK		25'
MINIMUM REAR YARD SETBACK		10'
MINIMUM SIDE YARD SETBACK		6'
MINIMUM SIDE YARD SETBACK ADJACENT TO A STREET		15'
MAXIMUM BUILDING COVERAGE		35%
MAXIMUM BUILDING HEIGHT		32'

GENERAL NOTES:

- 1:** As shown in the concept plan for *Tract K* above.
- 2:** As measured at the front building line.

- (4) **Garage Orientation.** *Front-Entry Garages* shall be prohibited.
- (5) **Landscaping and Entry Monumentation Signage.** The proposed development shall incorporate landscaping and entry monumentation signage that conforms to the *Landscaping and Entry Monumentation Signage* exhibit depicted in *Figure 2*.

FIGURE 2. LANDSCAPE AND ENTRY MONUMENTATION SIGNAGE

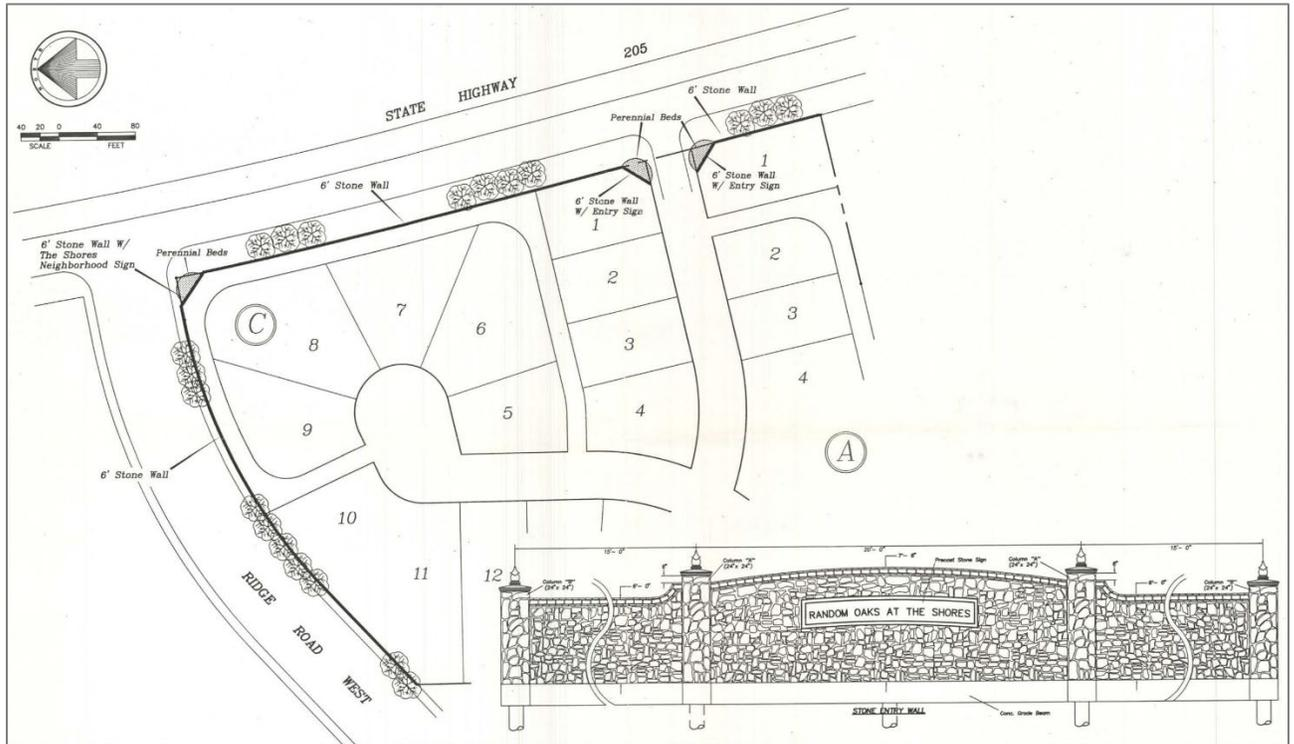

Exhibit 'D':
Density and Development Standards

(D) TRACT L. (Fairway Pointe at the Shores, Phase 3)

- (1) Permitted Land Uses. Unless specifically provided by this Planned Development District ordinance, *Tract L -- as depicted in Exhibit 'C' of this ordinance --* shall be subject to the land uses permitted within the Single-Family 10 (SF-10) District, as stipulated by the *Permissible Use Charts* contained in Article 04, *Permissible Uses*, of the Unified Development Code (UDC), as heretofore amended, as amended herein by granting this zoning change, and as maybe amended in the future.
- (2) Density and Development Standards. The development of *Tract L -- as depicted in Exhibit 'C' of this ordinance --* shall be subject to the density and dimensional standards stipulated for properties in a Single-Family 10 (SF-10) District as required by Subsection 03.07, *Single-Family 10 (SF-10) District*, of Article 05, *District Development Standards*, of the Unified Development Code [*Ordinance No. 20-02*] of the City of Rockwall as heretofore amended, as amended herein by granting this zoning change, and as maybe amended in the future. In addition, all lots in *Tract L* shall conform to the standards depicted in *Table 4*, which are as follows:

TABLE 4: LOT DIMENSIONAL REQUIREMENTS

	Lot Type (see Concept Plan) ►	L
MINIMUM LOT AREA	60% OF THE LOTS	8,400 SF
	40% OF THE LOTS	9,000 SF
AVERAGE LOT AREA FOR TRACT		10,000 SF
SINGLE-FAMILY DWELLING UNIT PER LOT		1
MINIMUM FLOOR AREA PER DWELLING UNIT	8,400 SF LOTS	2,000 SF
	9,000 SF LOTS	2,200 SF
MINIMUM LOT FRONTAGE ⁽¹⁾	8,400 SF LOTS	60'
	9,000 SF LOTS	70'
MINIMUM LOT DEPTH		100'
MINIMUM FRONT YARD SETBACK		20'
MINIMUM REAR YARD SETBACK		10'
MINIMUM SIDE YARD SETBACK		5'
MINIMUM SIDE YARD SETBACK ADJACENT TO A STREET		15'
MINIMUM BUILDING SEPERATION		10'
MAXIMUM BUILDING COVERAGE		45%
MAXIMUM BUILDING HEIGHT		35'
MINIMUM OFF-STREET PARKING (SPACES/UNIT) ⁽²⁾		2
MINIMUM GARAGE SPACE (VEHICLES SPACES)		2

GENERAL NOTES:

- ¹: Lot frontage shall be measured on a public street.
²: Excluding the required garage spaces.

**Exhibit 'D':
Density and Development Standards**

(E) TRACT M. (A portion of The Shores Club House Subdivision)

- (1) Concept Plan. All development of *Tract M* shall conform with the *Concept Plan* depicted in *Figure 3*.

FIGURE 3. CONCEPT PLAN FOR TRACT M



- (2) Permitted Land Uses. Unless specifically provided by this Planned Development District ordinance, *Tract M* -- as depicted in *Exhibit 'C'* of this ordinance -- shall be subject to the land uses permitted within the Single-Family 7 (SF-7) District, as stipulated by the *Permissible Use Charts* contained in Article 04, *Permissible Uses*, of the Unified Development Code (UDC), as heretofore amended, as amended herein by granting this zoning change, and as maybe amended in the future.
- (3) Density and Development Standards. The development of *Tract M* -- as depicted in *Exhibit 'C'* of this ordinance -- shall be subject to the density and dimensional standards stipulated for properties in a Single-Family 7 (SF-7) District as required by Subsection 03.09, *Single-Family 7 (SF-7) District*, of Article 05, *District Development Standards*, of the Unified Development Code [Ordinance No. 20-02] of the City of Rockwall as heretofore amended, as amended herein by granting this zoning change, and as maybe amended in the future. In addition, all lots in *Tract M* shall conform to the standards depicted in *Table 5*, which are as follows:

TABLE 5: LOT DIMENSIONAL REQUIREMENTS

**Exhibit 'D':
Density and Development Standards**

	<i>Lot Type (see Concept Plan) ►</i>	M
MINIMUM LOT AREA ⁽¹⁾		SEE (1) BELOW
SINGLE-FAMILY DWELLING UNITS PER LOT		1
MINIMUM FLOOR AREA PER DWELLING UNIT	LOT 17, BLOCK H	2,200 SF
	LOTS 18-21, BLOCK H	2,000 SF
MINIMUM LOT FRONTAGE ⁽¹⁾		SEE (1) BELOW
MINIMUM LOT DEPTH ⁽¹⁾		SEE (1) BELOW
MINIMUM FRONT YARD SETBACK		30'
MINIMUM REAR YARD SETBACK		25'
MINIMUM SIDE YARD SETBACK		10'
MINIMUM BUILDING SEPERATION		10'
MAXIMUM BUILDING COVERAGE		35%
MAXIMUM BUILDING HEIGHT		30'
MINIMUM OFF-STREET PARKING (SPACES/UNIT) ⁽²⁾		2

GENERAL NOTES:

¹: As shown in the concept plan for *Tract J* above.

²: Excluding the required garage spaces.

(4) Garage Orientation. No Garage shall open onto Champions Drive.

**Exhibit 'D':
Density and Development Standards**

(F) TRACT N. (The Shores, Phase 1)

(1) Concept Plan. All development of *Tract N* shall conform with the *Concept Plan* depicted in *Figure 4*.

FIGURE 4. CONCEPT PLAN FOR TRACT N

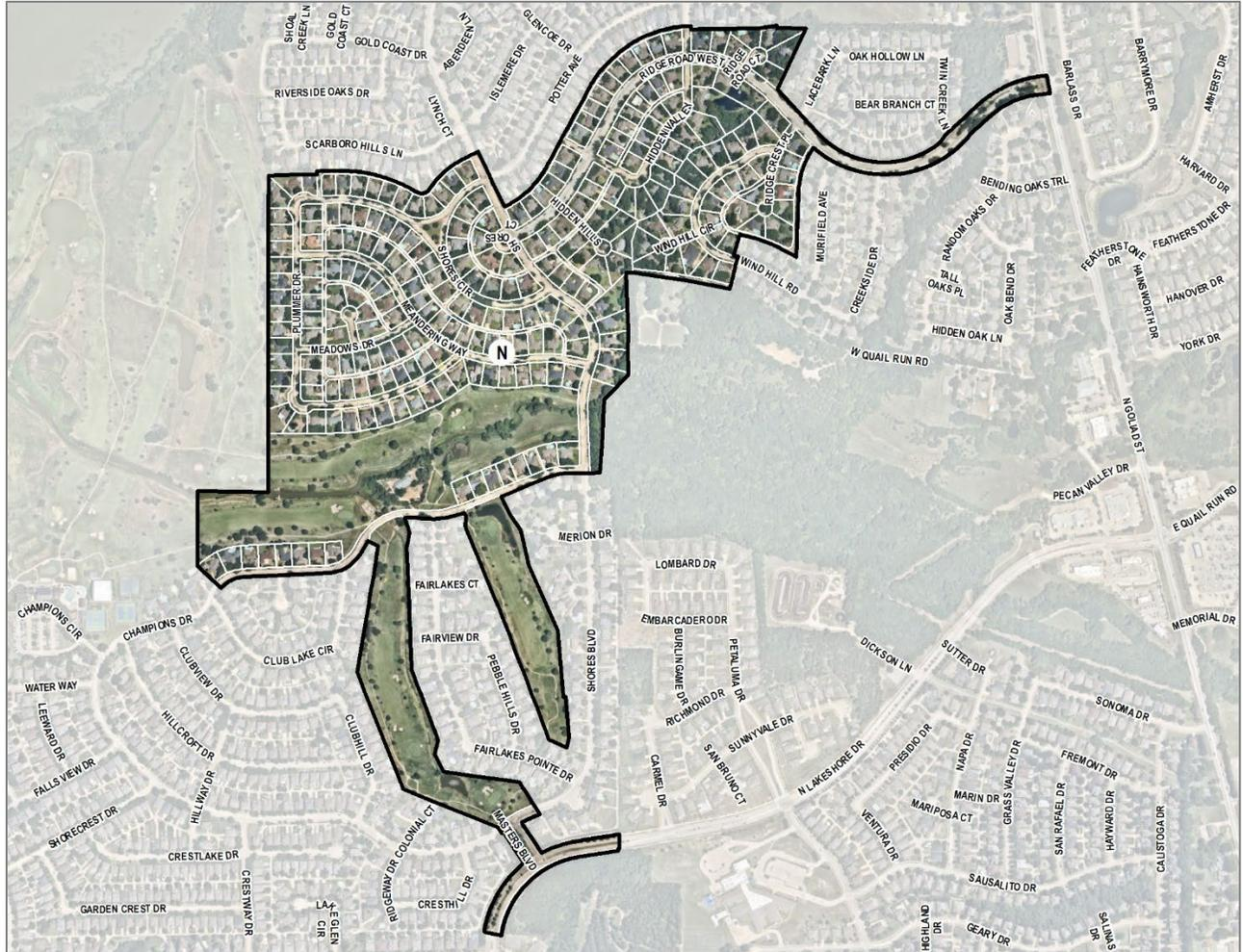

(2) Permitted Land Uses. Unless specifically provided by this Planned Development District ordinance, *Tract N* -- as depicted in *Exhibit 'C'* of this ordinance -- shall be subject to the land uses permitted within the Single-Family 10 (SF-10) District, as stipulated by the *Permissible Use Charts* contained in Article 04, *Permissible Uses*, of the Unified Development Code (UDC), as heretofore amended, as amended herein by granting this zoning change, and as maybe amended in the future.

(3) Density and Development Standards. The development of *Tract N* -- as depicted in *Exhibit 'C'* of this ordinance -- shall be subject to the density and dimensional standards stipulated for properties in a Single-Family 10 (SF-10) District as required by Subsection 03.07, *Single-Family 10 (SF-10) District*, of Article 05, *District Development Standards*, of the Unified Development Code [Ordinance No. 20-02] of the City of Rockwall as heretofore amended, as amended herein by granting this zoning change, and as maybe amended in the future; however, all lots in *Tract N* shall conform to the standards depicted in *Table 6*, which are as follows:

Exhibit 'D':
Density and Development Standards

TABLE 6: LOT DIMENSIONAL REQUIREMENTS

	<i>Lot Type (see Concept Plan) ►</i>	N
MINIMUM LOT AREA		9,000 SF
SINGLE-FAMILY DWELLING UNITS PER LOT		1
MINIMUM LOT FRONTAGE ⁽¹⁾		75'
MINIMUM LOT DEPTH		120'
MINIMUM FRONT YARD SETBACK ⁽¹⁾		25'
MINIMUM REAR YARD SETBACK ⁽²⁾		10'
MINIMUM SIDE YARD SETBACK ⁽³⁾		6'
MINIMUM SIDE YARD SETBACK ADJACENT TO A STREET		SEE (1) BELOW
MAXIMUM BUILDING COVERAGE		35%
MAXIMUM BUILDING HEIGHT ⁽⁴⁾		2½ STORIES

GENERAL NOTES:

- ¹: (OR) As depicted on the approved subdivision plat that was filed with Rockwall County on March 9, 1978.
- ²: Section 9-701 of the 1972 City of Rockwall Zoning Ordinance [*Single-Family 3 (SF-3) District*].
- ³: Section 9-601 of the 1972 City of Rockwall Zoning Ordinance [*Single-Family 3 (SF-3) District*].
- ⁴: Section 11-102 of the 1972 City of Rockwall Zoning Ordinance: In the districts where the height of buildings is restricted to two and one-half (2½) or three (3) stories, cooling towers, roof gables, chimneys and vent stacks may extend for an additional height not to exceed 40-feet above the average grade line of the building. Water stand pipes and tanks, church steeples, domes and spires and school buildings and institutional buildings may be erected to exceed three (3) stories in height, provided that one (1) additional foot shall be added to the width and depth of front, side and rear yards for each foot that such structures exceed three (3) stories.

**Exhibit 'D':
Density and Development Standards**

(G) TRACT O. (The Shores, Phase 2)

- (1) Concept Plan. All development of *Tract O* shall conform with the *Concept Plan* depicted in *Figure 5*.

FIGURE 5. CONCEPT PLAN FOR TRACT O



- (2) Permitted Land Uses. Unless specifically provided by this Planned Development District ordinance, *Tract O* -- as depicted in *Exhibit 'C'* of this ordinance -- shall be subject to the land uses permitted within the Single-Family 10 (SF-10) District, as stipulated by the *Permissible Use Charts* contained in Article 04, *Permissible Uses*, of the Unified Development Code (UDC), as heretofore amended, as amended herein by granting this zoning change, and as maybe amended in the future.
- (3) Density and Development Standards. The development of *Tract O* -- as depicted in *Exhibit 'C'* of this ordinance -- shall be subject to the density and dimensional standards stipulated for properties in a Single-Family 10 (SF-10) District as required by Subsection 03.07, *Single-Family 10 (SF-10) District*, of Article 05, *District Development Standards*, of the Unified Development Code [Ordinance No. 20-02] of the City of Rockwall as heretofore amended, as amended herein by granting this zoning change, and as maybe amended in the future; however, all lots in *Tract O* shall conform to the standards depicted in *Table 7*, which are as follows:

TABLE 7: LOT DIMENSIONAL REQUIREMENTS

Exhibit 'D':
Density and Development Standards

<i>Lot Type (see Concept Plan) ►</i>	O
MINIMUM LOT AREA ⁽¹⁾	9,000 SF
SINGLE-FAMILY DWELLING UNIT PER LOT	1
MINIMUM FLOOR AREA PER DWELLING UNIT	2,000 SF
MINIMUM LOT FRONTAGE ^{(1) & (2)}	75'
MINIMUM LOT DEPTH	120'
MINIMUM FRONT YARD SETBACK ⁽¹⁾	25'
MINIMUM REAR YARD SETBACK	10'
MINIMUM SIDE YARD SETBACK	6'
MINIMUM SIDE YARD SETBACK ADJACENT TO A STREET ⁽¹⁾	15'
MINIMUM BUILDING SEPERATION	10'
MAXIMUM BUILDING COVERAGE	35%
MAXIMUM BUILDING HEIGHT	2½ STORIES
MINIMUM OFF-STREET PARKING (SPACES/UNIT) ⁽³⁾	2
MINIMUM GARAGE SPACE (VEHICLES SPACES)	2

GENERAL NOTES:

- ¹: (OR) As depicted on the approved subdivision plat that was filed with Rockwall County on February 22, 1991.
- ²: Lot frontage shall be measured on a public street.
- ³: Excluding the required garage spaces.

Exhibit 'D':
Density and Development Standards

(H) TRACT P. (*The Shores, Phase 3*)

- (1) Concept Plan. All development of *Tract P* shall conform with the *Concept Plan* depicted in *Figure 6*.

FIGURE 6. CONCEPT PLAN FOR TRACT P



- (2) Permitted Land Uses. Unless specifically provided by this Planned Development District ordinance, *Tract P* -- as depicted in *Exhibit 'C'* of this ordinance -- shall be subject to the land uses permitted within the Single-Family 10 (SF-10) District, as stipulated by the *Permissible Use Charts* contained in Article 04, *Permissible Uses*, of the Unified Development Code (UDC), as heretofore amended, as amended herein by granting this zoning change, and as maybe amended in the future.
- (3) Density and Development Standards. The development of *Tract P* -- as depicted in *Exhibit 'C'* of this ordinance -- shall be subject to the density and dimensional standards stipulated for properties in a Single-Family 10 (SF-10) District as required by Subsection 03.07, *Single-Family 10 (SF-10) District*, of Article 05, *District Development Standards*, of the Unified Development Code [*Ordinance No. 20-02*] of the City of Rockwall as heretofore amended, as amended herein by granting this zoning change, and as maybe amended in the future; however, all lots in *Tract P* shall conform to the standards depicted in *Table 8*, which are as follows:

TABLE 8: LOT DIMENSIONAL REQUIREMENTS

Exhibit 'D':
Density and Development Standards

<i>Lot Type (see Concept Plan) ►</i>	P
MINIMUM LOT AREA ⁽¹⁾	8,400 SF
SINGLE-FAMILY DWELLING UNIT PER LOT	1
MINIMUM FLOOR AREA PER DWELLING UNIT	2,000 SF
MINIMUM LOT FRONTAGE ^{(1) & (2)}	75'
MINIMUM LOT DEPTH	120'
MINIMUM FRONT YARD SETBACK ⁽¹⁾	25'
MINIMUM REAR YARD SETBACK	10'
MINIMUM SIDE YARD SETBACK	6'
MINIMUM SIDE YARD SETBACK ADJACENT TO A STREET ⁽¹⁾	15'
MINIMUM BUILDING SEPERATION	10'
MAXIMUM BUILDING COVERAGE	35%
MAXIMUM BUILDING HEIGHT	2½ STORIES
MINIMUM OFF-STREET PARKING (SPACES/UNIT) ⁽³⁾	2
MINIMUM GARAGE SPACE (VEHICLES SPACES)	2

GENERAL NOTES:

- ¹: (OR) As depicted on the approved subdivision plat that was filed with Rockwall County on February 22, 1991.
- ²: Lot frontage shall be measured on a public street.
- ³: Excluding the required garage spaces.

CITY OF ROCKWALL

ORDINANCE NO. 23-54

AN ORDINANCE OF THE CITY COUNCIL OF THE CITY OF ROCKWALL, TEXAS, AMENDING THE UNIFIED DEVELOPMENT CODE [ORDINANCE NO. 20-02] OF THE CITY OF ROCKWALL, AS HERETOFORE AMENDED, BY AMENDING ARTICLE 05, DISTRICT DEVELOPMENT STANDARDS, AS DEPCITED IN EXHIBIT 'A' OF THIS ORDINANCE; PROVIDING FOR A PENALTY OF FINE NOT TO EXCEED THE SUM OF TWO THOUSAND DOLLARS (\$2,000.00) FOR EACH OFFENSE; PROVIDING FOR A SEVERABILITY CLAUSE; PROVIDING FOR A REPEALER CLAUSE; PROVIDING FOR AN EFFECTIVE DATE.

WHEREAS, an amendment to the City of Rockwall's Unified Development Code [*Ordinance No. 20-02*] has been initiated by the City Council of the City of Rockwall to amend Article 05, *District Development Standards*, of the Unified Development Code [*Ordinance No. 20-02*] to allow certain Homeowner's Associations (HOA's) the ability to lease the *Lake Ray Hubbard Takeline*; and,

WHEREAS, the Planning and Zoning Commission of the City of Rockwall and the governing body of the City of Rockwall in compliance with the laws of the State of Texas and the ordinances of the City of Rockwall have given the requisite notices by publication and otherwise, and have held public hearings and afforded a full and fair hearing to all property owners generally and to all persons interested in and situated in the city's corporate boundaries, and the governing body in the exercise of its legislative discretion, has concluded that the Unified Development Code [*Ordinance No. 20-02*] should be amended as follows:

NOW, THEREFORE, BE IT ORDAINED BY THE CITY COUNCIL OF THE CITY OF ROCKWALL, TEXAS:

SECTION 1. That Article 05, *District Development Standards*, of the Unified Development Code [*Ordinance No. 20-02*] of the City of Rockwall, as heretofore amended, be and the same is hereby amended as specifically described in *Exhibit 'A'* of this ordinance;

SECTION 2. That any person, firm, or corporation violating any of the provisions of this ordinance shall be deemed guilty of a misdemeanor and upon conviction shall be punished by a penalty of fine not to exceed the sum of *Two Thousand Dollars (\$2,000.00)* for each offense and each and every day such offense shall continue shall be deemed to constitute a separate offense;

SECTION 3. That if any section, paragraph, or provision of this ordinance or the application of that section, paragraph, or provision to any person, firm, corporation or situation is for any reason judged invalid, the adjudication shall not affect any other section, paragraph, or provision of this ordinance or the application of any other section, paragraph or provision to any other person, firm, corporation or situation, nor shall adjudication affect any other section, paragraph, or provision of the Unified Development Code [*Ordinance No. 20-02*], and the City Council declares that it would have adopted the valid portions and applications of the ordinance without the invalid parts and to this end the provisions for this ordinance are declared to be severable;

SECTION 4. That this ordinance shall take effect immediately from and after its passage.

PASSED AND APPROVED BY THE CITY COUNCIL OF THE CITY OF ROCKWALL, TEXAS, THIS THE 2ND DAY OF OCTOBER, 2023.

Trace Johannesen, Mayor

ATTEST:

Kristy Teague, City Secretary

APPROVED AS TO FORM:

Frank J. Garza, City Attorney

1st Reading: September 18, 2023

2nd Reading: October 2, 2023

Exhibit 'A'
*Article 05, District Development Standards, of the
Unified Development Code (UDC)*

Continued on Next Page ...

CITY OF ROCKWALL

ORDINANCE NO. 23-55

SPECIFIC USE PERMIT NO. S-315

AN ORDINANCE OF THE CITY COUNCIL OF THE CITY OF ROCKWALL, TEXAS, AMENDING THE UNIFIED DEVELOPMENT CODE (UDC) [ORDINANCE NO. 20-02] OF THE CITY OF ROCKWALL, ROCKWALL COUNTY, TEXAS, AS PREVIOUSLY AMENDED, SO AS TO GRANT A SPECIFIC USE PERMIT (SUP) FOR *RESIDENTIAL INFILL ADJACENT TO AN ESTABLISHED SUBDIVISION* TO ALLOW THE CONSTRUCTION OF A SINGLE-FAMILY HOME ON A 10.00-ACRE TRACT OF LAND, IDENTIFIED AS LOT 1, BLOCK A, BREEZY HILL LANE ADDITION, CITY OF ROCKWALL, ROCKWALL COUNTY, TEXAS; AND MORE SPECIFICALLY DESCRIBED AND DEPICTED IN *EXHIBIT 'A'* OF THIS ORDINANCE; PROVIDING FOR SPECIAL CONDITIONS; PROVIDING FOR A PENALTY OF FINE NOT TO EXCEED THE SUM OF TWO THOUSAND DOLLARS (\$2,000.00) FOR EACH OFFENSE; PROVIDING FOR A SEVERABILITY CLAUSE; PROVIDING FOR A REPEALER CLAUSE; PROVIDING FOR AN EFFECTIVE DATE.

WHEREAS, the City has received a request by Kaylee and Taylor Henson for the approval of a *Specific Use Permit (SUP)* for *Residential Infill Adjacent to an Established Subdivision* on a 10.00-acre tract of land identified as Lot 1, Block A, Breezy Hill Lane Addition, City of Rockwall, Rockwall County, Texas, zoned Agricultural (AG) District, addressed as 1325 Breezy Hill Lane, and being more specifically described and depicted in *Exhibit 'A'* of this ordinance, which herein after shall be referred to as the *Subject Property* and incorporated by reference herein; and

WHEREAS, the Planning and Zoning Commission of the City of Rockwall and the governing body of the City of Rockwall, in compliance with the laws of the State of Texas and the ordinances of the City of Rockwall, have given the requisite notices by publication and otherwise, and have held public hearings and afforded a full and fair hearing to all property owners generally, and to all persons interested in and situated in the affected area and in the vicinity thereof, the governing body in the exercise of its legislative discretion has concluded that the Unified Development Code (UDC) [*Ordinance No. 20-02*] of the City of Rockwall should be amended as follows:

NOW, THEREFORE, BE IT ORDAINED by the City Council of the City of Rockwall, Texas;

SECTION 1. That the Unified Development Code (UDC) [*Ordinance No. 20-02*] of the City of Rockwall, as heretofore amended, be and the same is hereby amended so as to grant a Specific Use Permit (SUP) for *Residential Infill Adjacent to an Established Subdivision* to allow for the construction of a single-family home adjacent to an established subdivision in accordance with Article 04, *Permissible Uses*, the Unified Development Code (UDC) [*Ordinance No. 20-02*] on the *Subject Property*; and,

SECTION 2. That the Specific Use Permit (SUP) shall be subject to the requirements set forth in Subsection 03.01, *General Residential District Standards*, and Subsection 02.01, *Agricultural (AG) District*, of Article 05, *District Development Standards*, of the Unified Development Code

(UDC) [Ordinance No. 20-02] -- as heretofore amended and may be amended in the future -- and with the following conditions:

2.1 OPERATIONAL CONDITIONS

The following conditions pertain to the construction of a single-family home and on the *Subject Property* and conformance to these operational conditions are required:

- 1) The development of the *Subject Property* shall generally conform to the Residential Plot Plan as depicted in *Exhibit 'B'* of this ordinance.
- 2) The construction of a single-family home on the *Subject Property* shall generally conform to the Building Elevations depicted in *Exhibit 'C'* of this ordinance.

2.2 COMPLIANCE

Approval of this ordinance in accordance with Subsection 02.02, *Specific Use Permits (SUP)* of Article 11, *Development Applications and Review Procedures*, of the Unified Development Code (UDC) will require the *Subject Property* to comply with the following:

- 1) Upon obtaining a *Building Permit*, should the contractor operating under the guidelines of this ordinance fail to meet the minimum operational requirements set forth herein and outlined in the Unified Development Code (UDC), the City may (*after proper notice*) initiate proceedings to revoke the Specific Use Permit (SUP) in accordance with Subsection 02.02(F), *Revocation*, of Article 11, *Development Applications and Revision Procedures*, of the Unified Development Code (UDC) [Ordinance No. 20-02].

SECTION 3. That the official zoning map of the City be corrected to reflect the changes in zoning described herein.

SECTION 4. That all ordinances of the City of Rockwall in conflict with the provisions of this ordinance be, and the same are hereby repealed to the extent of that conflict.

SECTION 5. Any person, firm, or corporation violating any of the provisions of this ordinance shall be deemed guilty of a misdemeanor and upon conviction shall be punished by a penalty of fine not to exceed the sum of *TWO THOUSAND DOLLARS (\$2,000.00)* for each offence and each and every day such offense shall continue shall be deemed to constitute a separate offense.

SECTION 6. If any section or provision of this ordinance or the application of that section or provision to any person, firm, corporation, situation or circumstance is for any reason judged invalid, the adjudication shall not affect any other section or provision of this ordinance or the application of any other section or provision to any other person, firm, corporation, situation or circumstance, and the City Council declares that it would have adopted the valid portions and applications of the ordinance without the invalid parts and to this end the provisions of this ordinance shall remain in full force and effect.

SECTION 7. That this ordinance shall take effect immediately from and after its passage.

PASSED AND APPROVED BY THE CITY COUNCIL OF THE CITY OF ROCKWALL, TEXAS, THIS THE 2nd DAY OF OCTOBER, 2023.

Trace Johannesen, Mayor

ATTEST:

Kristy Teague, City Secretary

APPROVED AS TO FORM:

Frank J. Garza, City Attorney

1st Reading: September 18, 2023

2nd Reading: October 2, 2023

**Exhibit 'A':
Location Map**

Address: 1325 Breezy Hill Lane

Legal Description: Lot 1, Block A, Breezy Hill Lane Addition

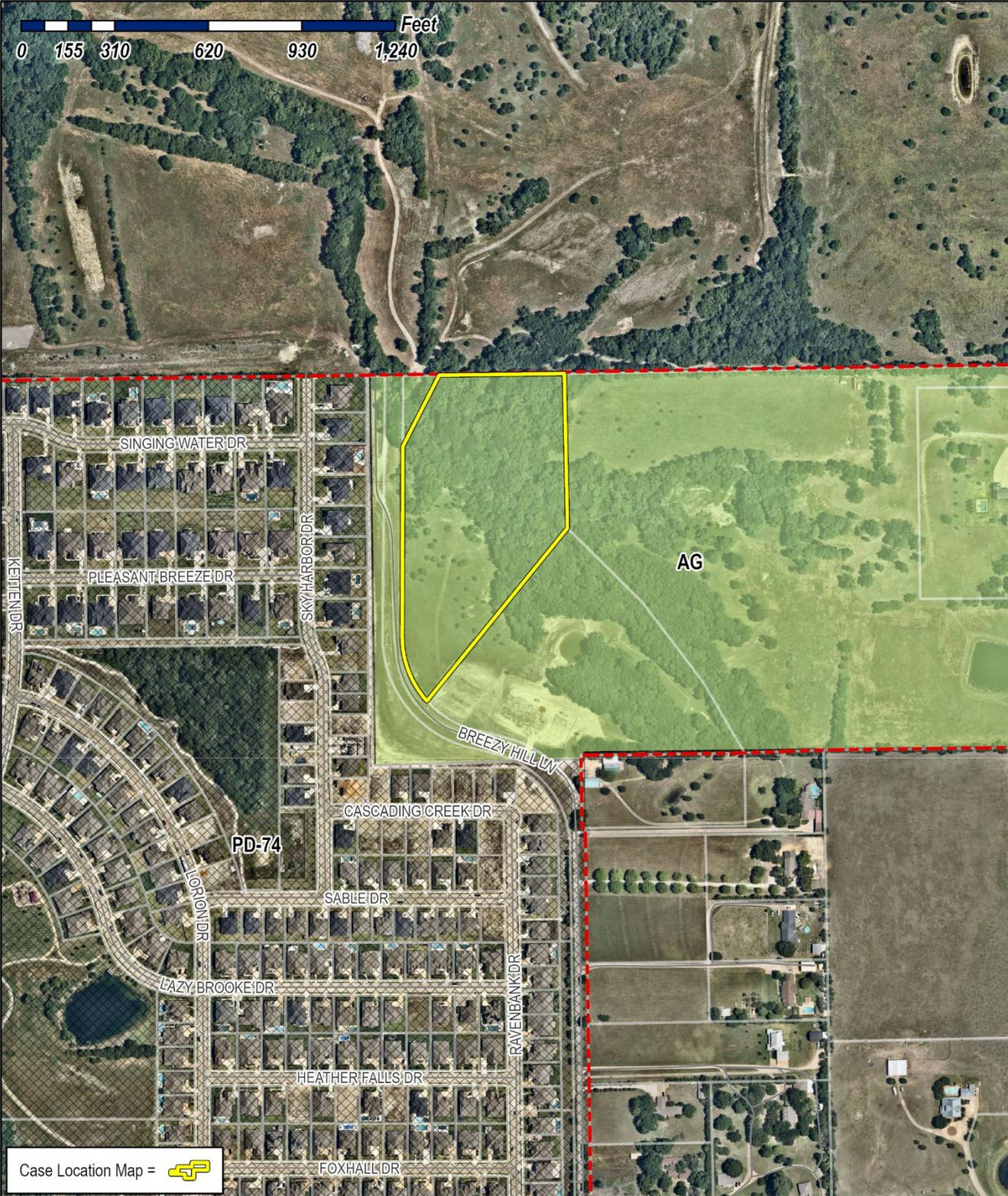

**Exhibit 'C':
Building Elevations**

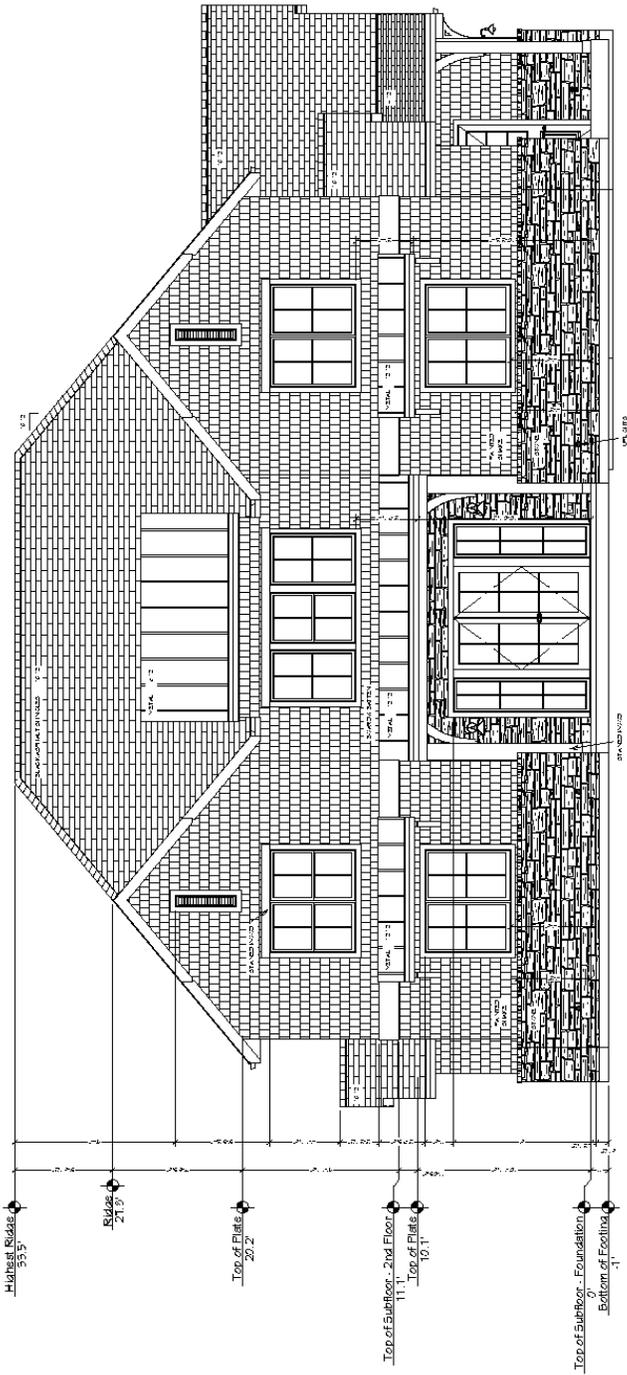

E1
FRONT EXTERIOR ELEVATION
SCALE: 1/4"=1'-0"

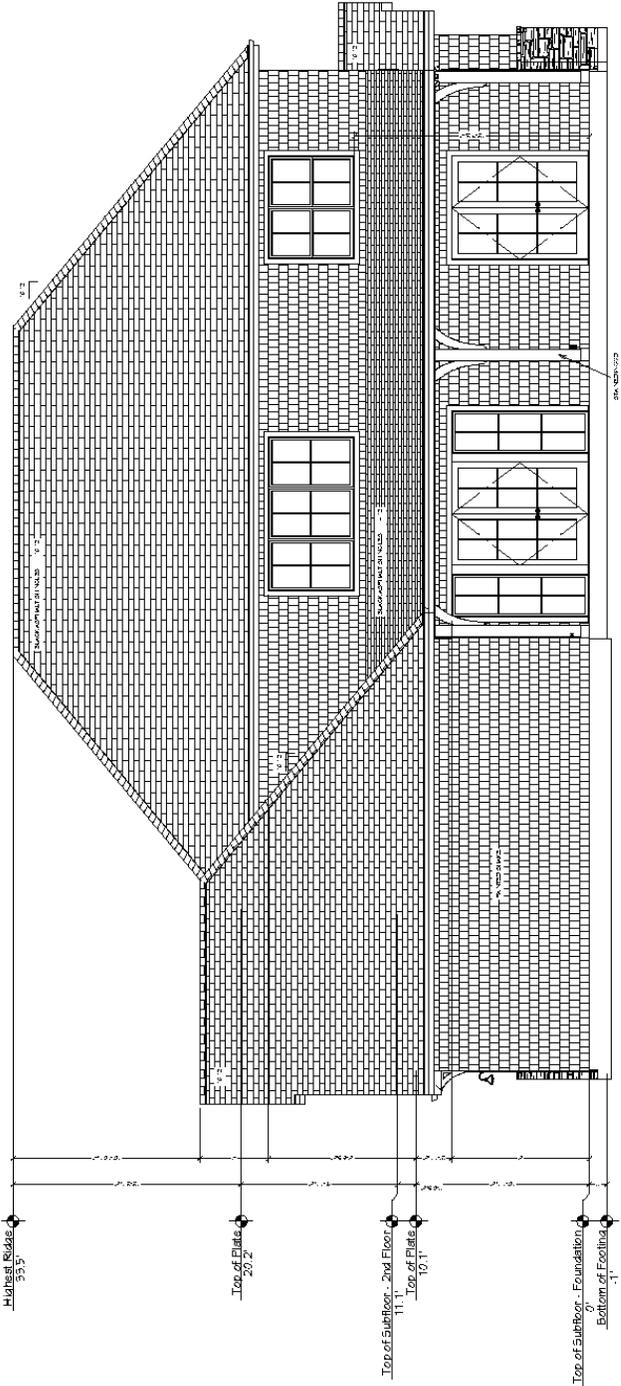

E2
REAR EXTERIOR ELEVATION
SCALE: 1/4"=1'-0"

Exhibit 'C':
Building Elevations

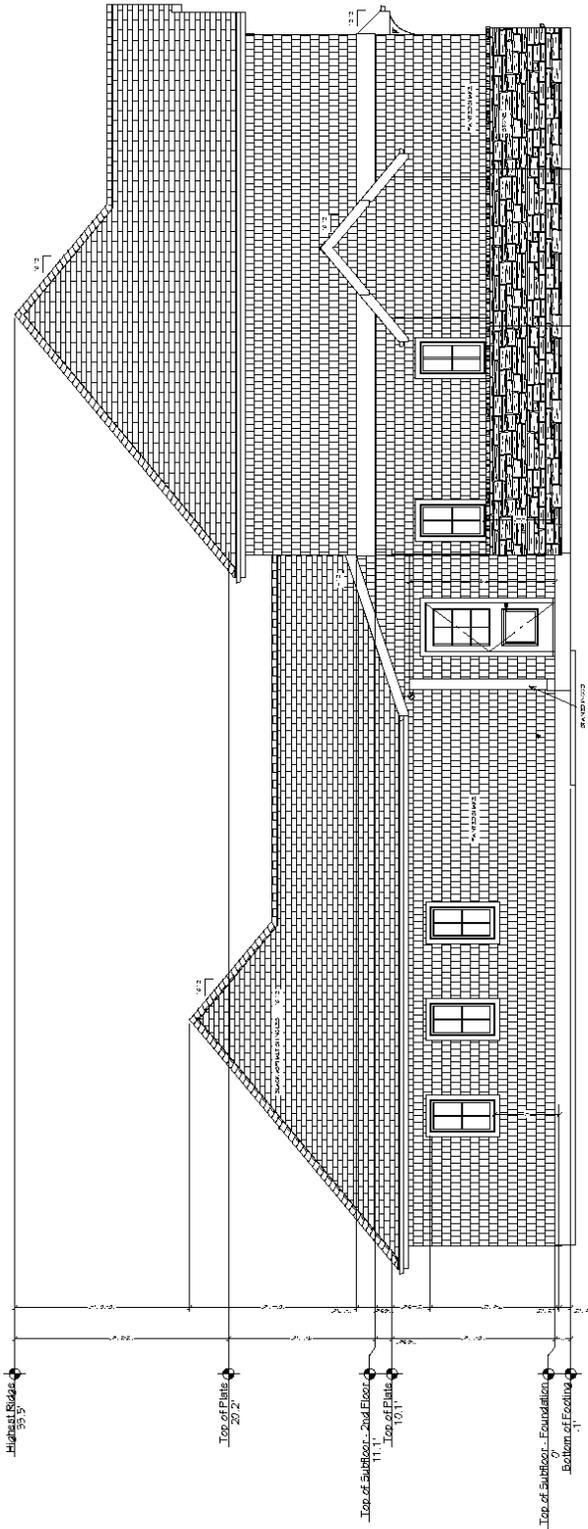

E3 LEFT EXTERIOR ELEVATION
SCALE: 1/4"=1'-0"

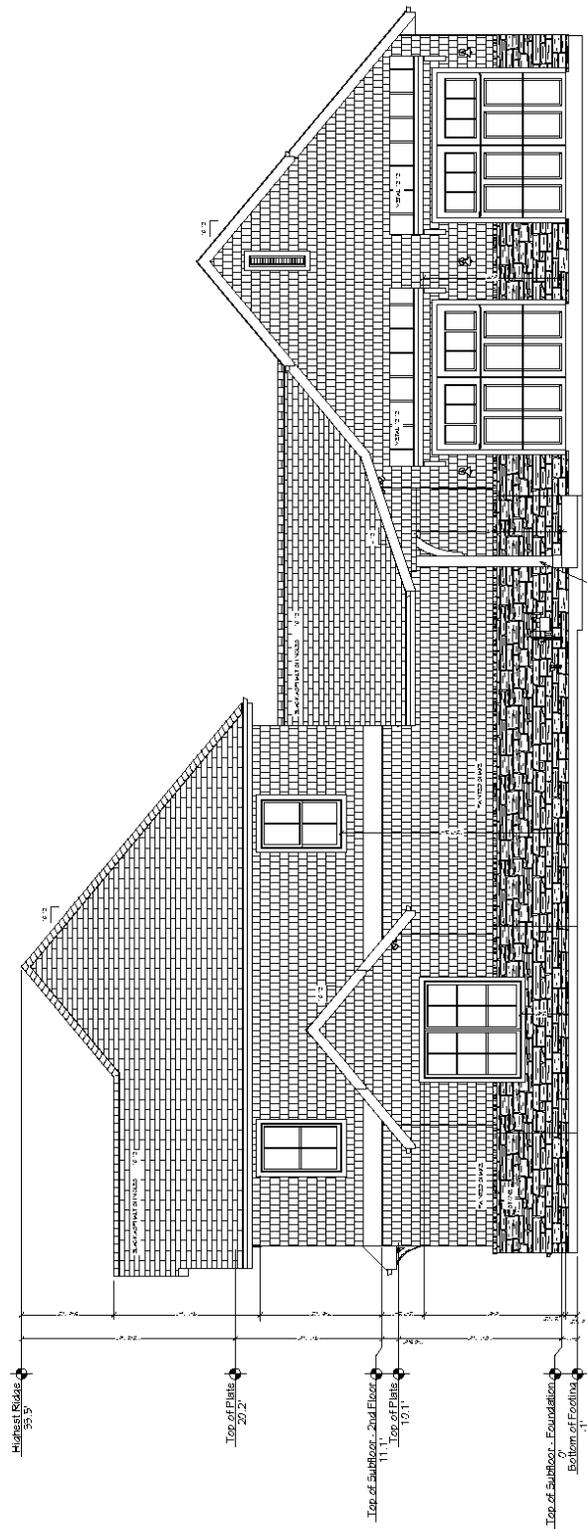

E4 RIGHT EXTERIOR ELEVATION
SCALE: 1/4"=1'-0"

Exhibit 'C':
Building Elevations



CITY OF ROCKWALL

ORDINANCE NO. 23-56

AN ORDINANCE OF THE CITY COUNCIL OF THE CITY OF ROCKWALL, TEXAS, AMENDING THE UNIFIED DEVELOPMENT CODE [ORDINANCE NO. 20-02] OF THE CITY OF ROCKWALL, AS HERETOFORE AMENDED, SO AS TO APPROVE A CHANGE IN ZONING FROM AN AGRICULTURAL (AG) DISTRICT AND A LIGHT INDUSTRIAL (LI) DISTRICT TO A COMMERCIAL (C) DISTRICT FOR A 66.057-ACRE TRACT OF LAND IDENTIFIED AS LOT 1, BLOCK B; LOT 1R, BLOCK C; AND LOT 1, BLOCK D, ROCKWALL COMMERCIAL ADDITION, CITY OF ROCKWALL, ROCKWALL COUNTY, TEXAS, AND BEING MORE SPECIFICALLY DESCRIBED IN EXHIBIT 'A' AND FURTHER DEPICTED IN EXHIBIT 'B' OF THIS ORDINANCE; PROVIDING FOR SPECIAL CONDITIONS; PROVIDING FOR A PENALTY OF FINE NOT TO EXCEED THE SUM OF TWO THOUSAND DOLLARS (\$2,000.00) FOR EACH OFFENSE; PROVIDING FOR A SEVERABILITY CLAUSE; PROVIDING FOR A REPEALER CLAUSE; PROVIDING FOR AN EFFECTIVE DATE.

WHEREAS, the City has received a request from Anthony Loeffel of Kimley-Horn on behalf of James Melino of Rockwall 549/I-30 Partners, LP and Conveyor I30 Partners, LP for the approval of a *Zoning Change* from an Agricultural (AG) District and Light Industrial (LI) District to a Commercial (C) District for a 66.057-acre tract of land identified as Lot 1, Block B; Lot 1R, Block C; and Lot 1, Block D, Rockwall Commercial Addition, City of Rockwall, Rockwall County, Texas, zoned Agricultural (AG) District and Light Industrial (LI) District, situated within the IH-30 Overlay (IH-30 OV) District, generally located at the northwest corner of Stodghill Road and the IH-30 Frontage Road, and more fully described in *Exhibit 'A'* and depicted in *Exhibit 'B'* of this ordinance, which hereinafter shall be referred to as the *Subject Property* and incorporated by reference herein; and

WHEREAS, the Planning and Zoning Commission of the City of Rockwall and the governing body of the City of Rockwall in compliance with the laws of the State of Texas and the ordinances of the City of Rockwall have given the requisite notices by publication and otherwise, and have held public hearings and afforded a full and fair hearing to all property owners generally and to all persons interested in and situated in the affected area, and in the vicinity thereof, and the governing body in the exercise of its legislative discretion, has concluded that the Unified Development Code (UDC) [*Ordinance No. 20-02*] should be amended as follows:

NOW, THEREFORE, BE IT ORDAINED BY THE CITY COUNCIL OF THE CITY OF ROCKWALL, TEXAS:

SECTION 1. That the Unified Development Code (UDC) [*Ordinance No. 20-02*] of the City of Rockwall, Texas, as heretofore amended, be and the same are hereby amended by amending the zoning map of the City of Rockwall so as to change the zoning of the *Subject Property* from Agricultural (AG) District and Light Industrial (LI) District to a Commercial (C) District;

SECTION 2. That the *Subject Property* shall be used only in the manner and for the purposes provided for a Commercial (C) District as stipulated in Section 01.01, *Use of Land and Buildings*, of Article 04, *Permissible Uses* and Section 04.01, *General Commercial District Standards*;

Section 04.05, *Commercial (C) District*; Section 06.02, *General Overlay District Standards*, of Article 05, *District Development Standards*, of the Unified Development Code (UDC) [Ordinance No. 20-02] of the City of Rockwall as heretofore amended, as amended herein by granting of this zoning change, and as maybe amended in the future;

SECTION 3. That the official zoning map of the City be corrected to reflect the changes in the zoning described herein;

SECTION 4. Any person, firm, or corporation violating any of the provisions of this ordinance shall be deemed guilty of a misdemeanor and upon conviction shall be punished by a penalty of fine not to exceed the sum of *Two Thousand Dollars (\$2,000.00)* for each offence and each and every day such offense shall continue shall be deemed to constitute a separate offense;

SECTION 5. If any section, paragraph, or provision of this ordinance or the application of that section, paragraph, or provision to any person, firm, corporation or situation is for any reason judged invalid, the adjudication shall not affect any other section, paragraph, or provision of this ordinance or the application of any other section, paragraph or provision to any other person, firm, corporation or situation, nor shall adjudication affect any other section, paragraph, or provision of the Unified Development Code (UDC) of the City of Rockwall, Texas, and the City Council declares that it would have adopted the valid portions and applications of the ordinance without the invalid parts and to this end the provisions for this ordinance are declared to be severable; and

SECTION 6. That all ordinances of the City of Rockwall in conflict with the provisions of this ordinance be and the same are hereby repealed, and all other ordinances of the City of Rockwall not in conflict with the provisions of this ordinance shall remain in full force and effect;

SECTION 7. That this ordinance shall take effect immediately from and after its passage.

PASSED AND APPROVED BY THE CITY COUNCIL OF THE CITY OF ROCKWALL, TEXAS, THIS THE 2nd DAY OF OCTOBER, 2023.

Trace Johannessen, Mayor

ATTEST:

Kristy Teague, City Secretary

APPROVED AS TO FORM:

Frank J. Garza, City Attorney

1st Reading: September 18, 2023

2nd Reading: October 2, 2023

Exhibit 'A'
Legal Description

TRACT 1

BEING a tract of land situated in the E.M. Elliot Survey, Abstract No. 77 and John Lockhart Survey, Abstract No. 134, City of Rockwall, Rockwall County, Texas and being all of Lot 1R, Block C of Rockwall Commercial, an addition to the City of Rockwall, Texas, according to the Plat thereof recorded in Instrument No. 20210000008470 of the Plat Records of Rockwall County, Texas.

TRACT 2

BEING a tract of land situated in the E.M. Elliott Survey, Abstract No. 77 and the John Lockhart Survey, Abstract No. 134, City of Rockwall, Rockwall County, Texas and being a portion of Lot 1, Block B of Rockwall Commercial, an addition to the City of Rockwall, Texas according to the plat thereof recorded in Instrument Number 20210000008470, Plat Records of Rockwall County, Texas, and being a portion of Lot 1, Block D of Rockwall Commercial Park an addition to the City of Rockwall, Texas, according to the plat thereof recorded in Cabinet B, Slide 206, Plat Records of Rockwall County, Texas, same being a portion of a called 8.40 gross acre tract of land, described in a Special Warranty Deed to Conveyor/I-30 Partners LP, as recorded in Volume 7077, Page 201, Real Property Records of Rockwall County, Texas, and being more particularly described by the metes and bounds as follows:

BEGINNING at a 5/8" iron rod with a cap stamped "TXDOT" found for the southwest corner of said Lot 1, Block D and the northeast corner of the intersection of northerly right-of-way line of Interstate Highway 30 (a variable width right-of-way) with the easterly right-of-way line of Conveyors Street (a 60-foot right-of-way), same being at the beginning of a non-tangent curve to the right with a radius of 397.84 feet, a central angle of 13°52'57", and a chord bearing and distance of North 10°51'16" West, 96.16 feet;

THENCE in a northerly direction, along the common line of said Lot 1, Block D and the easterly right-of-way line of said Conveyors Street, and with said non-tangent curve to the right, an arc distance of 96.40 feet to a 5/8" iron rod with a red plastic cap stamped "KHA" set for corner;

THENCE North 03°13'23" West, continuing along the common line of said Lot 1, Block D and the easterly right-of-way line of said Conveyors Street, passing at a distance of 228.03 feet a 5/8" iron rod with a red plastic cap stamped "KHA" found for the northernmost southwest corner of said Lot 1, Block B, continuing along the common line of said Lot 1, Block B and the easterly right-of-way line of said Conveyors Street a total distance of 706.26 feet to a 5/8" iron rod with a red plastic cap stamped "KHA" found at the beginning of a tangent curve to the right with a radius of 1,170.00 feet, a central angle of 15°08'16", and a chord bearing and distance of North 04°20'45" East, 308.22 feet;

THENCE in a northerly direction, along the common line of said Lot 1, Block B and the easterly right-of-way line of said Conveyors Street the following courses and distances:

In a northerly direction, with said tangent curve to the right, an arc distance of 309.12 feet to the beginning of a reverse curve to the left with a radius of 530.00 feet, a central angle of 13°38'17", and a chord bearing and distance of North 05°05'50" East, 125.86 feet, from which a 5/8" iron rod with plastic cap stamped "KHA" found bears South 57°02'14" East, a distance of 0.35 feet;

In a northerly direction, with said reverse curve to the left, an arc distance of 126.15 feet to a 5/8" iron rod with a red plastic cap stamped "KHA" found for corner;

North 01°43'20" West, a distance of 9.59 feet to a 5/8" iron rod with plastic cap stamped "KHA" found for the most southerly northwest corner of said Lot 1, Block B same being the southernmost end of a right-of-way corner clip at the intersection of the east right-of-way line of said Conveyors Street and the south right-of-way line of Justin Road (a 85' right-of-way), recorded in 20210000008470, Plat Records of Rockwall County, Texas;

THENCE North 43°16'40" East, along said right-of-way corner clip, a distance of 42.43 feet to a 5/8" iron rod with plastic cap stamped "KHA" found for the northernmost end of said right-of-way clip same being the

Exhibit 'A'
Legal Description

most northerly northwest corner of said Lot 1, Block B;

THENCE North 88°16'40" East, along the common line of the southerly right-of-way line of said Justin Road and the north line of said Lot 1, Block B, a distance of 261.47 feet to a point for corner on the easterly line of said 8.40 gross acre tract and the westerly line of a called 80.79-acre tract of land, described in a Special Warranty Deed to Rockwall 549/I-30 Partners, L.P., recorded in Volume 4924, Page 273, Real Property Records of Rockwall County, Texas;

THENCE South 01°12'38" East, departing the common line of the southerly right-of-way line of said Justin Road and the north line of said Lot 1, Block B, along the easterly line of said 8.40 gross acre tract and the westerly line of said 80.79-acre tract and crossing said Lot 1, Block B, a distance of 944.82 feet to a 1/2-inch iron rod found for the easterly, southeast corner of said 8.40 gross acre tract and the northeast corner of a called 1.00 acre tract of land, described in a Special Warranty Deed to Rockwall 549/I-30 Partners, L.P., recorded in Volume 5319, Page 243, Real Property Records of Rockwall County, Texas, same also being an ell corner of said Lot 1, Block B;

THENCE South 87°29'50" West, along the southerly line of said 8.40 gross acre tract, the southerly line of said Lot 1, Block B, and the northerly line of said called 1.00-acre tract, a distance of 163.20 feet to a 1/2-inch iron rod found for the northwest corner of said 1.00-acre tract and an ell corner of said 8.40 gross acre tract;

THENCE South 01°17'14" East, departing the southerly line of said Lot 1, Block B, along an easterly line of said 8.40 gross acre tract and the westerly line of said 1.00-acre tract and crossing aforesaid Lot 1, Block D, a distance of 288.54 feet to a 1/2-inch iron rod with a plastic cap, stamped "RPLS 5034" found for the southwest corner of said 1.00-acre tract, the southerly and the southeast corner of said 8.40 gross acre tract, same being on the southerly line of aforesaid Lot 1, Block D and the northerly right-of-way line of aforesaid Interstate Highway 30;

THENCE South 72°46'08" West, along the southerly line of said 8.40 gross acre tract, the southerly line of said Lot 1, Block D and along the northerly right of way line of said Interstate Highway 30, a distance of 136.40 feet to the **POINT OF BEGINNING** and containing 349,085 square feet or 8.014 acres of land, more or less.

TRACT 3

BEING a tract of land situated in the E.M. Elliott Survey, Abstract No. 77 and the John Lockhart Survey, Abstract No. 134, City of Rockwall, Rockwall County, Texas and being a portion of Lot 1, Block B of Rockwall Commercial, an addition to the City of Rockwall, Texas according to the plat thereof recorded in Instrument Number 2021000008470, Plat Records of Rockwall County, Texas, and a portion of Lot 1, Block D of Rockwall Commercial Park an addition to the City of Rockwall, Texas, according to the plat thereof recorded in Cabinet B, Slide 206, Plat Records of Rockwall County, Texas, same being a portion of a called 80.79-acre tract of land, described in a Special Warranty Deed to Rockwall 549/I-30 Partners, L.P., recorded in Volume 4924, Page 273, and all of a called 1.00-acre tract of land, described in a Special Warranty Deed to Rockwall 549/I-30 Partners, L.P., recorded in Volume 5319, Page 243, both of the Real Property Records of Rockwall County, Texas, and being more particularly described by the metes and bounds as follows:

BEGINNING at a 5/8" iron rod with a red plastic cap stamped "KHA" found for the most southerly southeast corner of said Lot 1, Block B and in the northerly right-of-way line of Interstate Highway 30 (a variable width right-of-way);

THENCE along the common line of said Lot 1, Block B and the northerly right-of-way line of said Interstate Highway 30, the following courses and distances:

South 72°46'18" West, a distance of 384.46 feet to a 5/8" iron rod with a red plastic cap stamped "KHA" set for corner;

Exhibit 'A'
Legal Description

South 64°14'27" West, a distance of 202.24 feet to a 5/8" iron rod with a red plastic cap stamped "KHA" set for corner;

THENCE South 72°46'08" West, continuing along said common line and the south line of said Lot 1, Block D, and passing at a distance of 1507.74 feet a 5/8" iron rod with a red plastic cap stamped "KHA" found for the southeast corner of said Lot 1, Block D, continuing along said line a total distance of 1,677.69 feet to a 1/2-inch iron rod found for the southwest corner of aforesaid 1.00-acre tract, same being the southerly, southeast corner of a called 8.40 gross acre tract of land, described in a Special Warranty Deed to Conveyor/I-30 Partners LP, as recorded in Volume 7077, Page 201, Real Property Records of Rockwall County, Texas;

THENCE North 01°17'14" West, departing the northerly right-of-way line of said Interstate Highway 30 and the southerly line of said Lot 1, Block D, along an easterly line of said 8.40 gross acre tract and the westerly line of said 1.00-acre tract and crossing said Lot 1, Block D, a distance of 288.54 feet to a 1/2-inch iron rod found for the northwest corner of said 1.00-acre tract and an ell corner of said 8.40 gross acre tract, same also being on a southerly line of aforesaid Lot 1, Block B;

THENCE North 87°29'50" East, along the southerly line of said 8.40 gross acre tract, the southerly line of said Lot 1, Block B, and the northerly line of said called 1.00-acre tract, a distance of 163.20 feet to a 1/2-inch iron rod found for the northeast corner of said 1.00-acre tract and the easterly, southeast corner of said 8.40 gross acre tract and an ell corner of said Lot 1, Block B, same being on the westerly line of aforesaid 80.79-acre tract;

THENCE North 01°12'38" West, departing the southerly line of said Lot 1, Block B, along the easterly line of said 8.40 gross acre tract and the westerly line of said 80.79-acre tract and crossing said Lot 1, Block B, a distance of 944.82 feet to a point for on the corner on the south right-of-way line of Justin Road (a 85' right-of-way), recorded in 2021000008470, Plat Records of Rockwall County, Texas and the north line of said Lot 1, Block B;

THENCE along the common line of the southerly right-of-way line of said Justin Road and the north line of said Lot 1, Block B, the following courses and distance:

North 88°16'40" East, a distance of 331.59 feet to a 5/8" iron rod with a red plastic cap stamped "KHA" found at the beginning of a tangent curve to the left with a radius of 1,592.50 feet, a central angle of 17°40'38", and a chord bearing and distance of North 79°26'21" East, 489.38 feet;

In an easterly direction, with said tangent curve to the left, an arc distance of 491.33 feet to a 5/8" iron rod with a red plastic cap stamped "KHA" found at the beginning of a reverse curve to the right with a radius of 3,979.40 feet, a central angle of 18°16'32", and a chord bearing and distance of North 79°44'18" East, 1,263.93 feet;

In an easterly direction, with said reverse curve to the right, an arc distance of 1,269.31 feet to a 5/8" iron rod with a red plastic cap stamped "KHA" found for corner;

North 88°52'34" East, a distance of 49.83 feet to a 5/8" iron rod with a red plastic cap stamped "KHA" found for the most northerly northeast corner of said Lot 1, Block B same being the northernmost end of a right-of-way corner clip at the intersection of the south right-of-way line of said Justin Road and the west right-of-way line of F.M. Highway 3549 (a variable width right-of-way);

THENCE South 46°07'44" East, along said right-of-way corner clip, a distance of 42.43 feet to a 5/8" iron rod with a red plastic cap stamped "KHA" found for the southernmost corner of said corner clip same being the most southerly northeast corner of said Lot 1, Block B;

THENCE along the westerly right-of-way line of said F.M. Highway 3549 and the east line of said Lot 1,

Exhibit 'A'
Legal Description

Block B the following courses and distances:

South 01°08'02" East, a distance of 165.78 feet to a 5/8" iron rod found for corner;

South 01°26'27" West, a distance of 113.61 feet to a 5/8" iron rod found for corner;

South 58°12'55" West, a distance of 98.69 feet to a 5/8" iron rod with a red plastic cap stamped "KHA" found for corner;

South 01°07'09" East, a distance of 441.34 feet to a 5/8" iron rod with a red plastic cap stamped "KHA" set for the northernmost southeast corner of said Lot 1, Block B, from which a 5/8" iron rod found (disturbed) bears South 30°38'33" East, a distance of 1.35 feet;

South 35°33'35" West, a distance of 80.25 feet to the **POINT OF BEGINNING** and containing 2,175,068 square feet or 49.933 acres of land, more or less.

CITY OF ROCKWALL

ORDINANCE NO. 23-57

SPECIFIC USE PERMIT NO. S-316

AN ORDINANCE OF THE CITY COUNCIL OF THE CITY OF ROCKWALL, TEXAS, AMENDING THE UNIFIED DEVELOPMENT CODE [ORDINANCE NO. 20-02] OF THE CITY OF ROCKWALL, TEXAS, AS PREVIOUSLY AMENDED, SO AS TO GRANT A SPECIFIC USE PERMIT (SUP) TO ALLOW A RESTAURANT, WITH 2,000 SF OR MORE WITH A DRIVE-THROUGH OR DRIVE-IN ON A 1.93-ACRE PARCEL OF LAND IDENTIFIED AS LOTS 8 & 9, BLOCK A, DALTON-GOLIAD ADDITION, CITY OF ROCKWALL, ROCKWALL COUNTY, TEXAS; PROVIDING FOR SPECIAL CONDITIONS; PROVIDING FOR A PENALTY OR FINE NOT TO EXCEED THE SUM OF TWO THOUSAND DOLLARS (\$2,000.00) FOR EACH OFFENSE; PROVIDING FOR A SEVERABILITY CLAUSE; PROVIDING FOR A REPEALER CLAUSE; PROVIDING FOR AN EFFECTIVE DATE.

WHEREAS, a request has been made by Juan Vasquez of Vasquez Engineering, LLC on behalf of Shane Shoulders of Kennor Rockwall Retail, LLC for the approval of a Specific Use Permit (SUP) for a *Restaurant, with 2,000 SF or More, with a Drive-Through or Drive-In* on a 1.93-acre parcel of land identified as Lots 8 & 9, Block A, Dalton-Goliad Addition, City of Rockwall, Rockwall County, Texas, zoned General Retail (GR) District, situated within the North SH-205 Overlay (N. SH-205 OV) District, addressed as 3611 & 3775 N. Goliad Street [*SH-205*], and being more specifically described and depicted in *Exhibit 'A'* of this ordinance, which herein after shall be referred to as the *Subject Property* and incorporated by reference herein; and

WHEREAS, the Planning and Zoning Commission of the City of Rockwall and the governing body of the City of Rockwall, in compliance with the laws of the State of Texas and the ordinances of the City of Rockwall, have given the requisite notices by publication and otherwise, and have held public hearings and afforded a full and fair hearing to all property owners generally, and to all persons interested in and situated in the affected area and in the vicinity thereof, the governing body in the exercise of its legislative discretion has concluded that the Unified Development Code [*Ordinance No. 20-02*] of the City of Rockwall should be amended as follows:

NOW, THEREFORE, BE IT ORDAINED BY THE CITY COUNCIL OF THE CITY OF ROCKWALL, TEXAS:

SECTION 1. The Unified Development Code [*Ordinance No. 20-02*] of the City of Rockwall, as heretofore amended, be and the same is hereby amended so as to grant a Specific Use Permit (SUP) allowing for the establishment of a *Restaurant, with 2,000 SF or More, with a Drive-Through or Drive-In* as stipulated by Article 04, *Permissible Uses*, of the Unified Development Code [*Ordinance No. 20-02*] on the *Subject Property*; and

SECTION 2. That the *Subject Property* shall be used and developed only in the manner and for the purposes described in this Specific Use Permit (SUP) ordinance and as specifically set forth in Subsection 01.01, *Land Use Schedule*, of Article 04, *Permissible Uses*, and Subsection 04.01, *General Commercial District Standards*; Subsection 04.04, *General Retail (GR) District*; and Subsection 06.02, *General Overlay District Standards*, of Article 05, *District Development Standards*, of the Unified Development Code [*Ordinance No. 20-02*] of the City of Rockwall -- as *heretofore amended and may be amended in the future* -- and with the following conditions:

2.1 OPERATIONAL CONDITIONS

The following conditions pertain to the operation of a *Restaurant, with 2,000 SF or More, with a Drive-Through or Drive-In* on the *Subject Property* and conformance to these requirements is necessary for continued operations:

- 1) Additional landscape screening shall be installed adjacent to drive-through lane, drive aisle adjacent to the residential land uses north of the subject property, and along N. Goliad Street [SH-205] to impair the visibility and impact of head-lights from motor vehicles in the drive-through lane on adjacent properties and rights-of-way. The additional landscaping will be approved by the Planning and Zoning Commission with the site plan approval for the proposed development depicted in *Exhibit 'B'*.
- 2) The proposed drive-through lane shall accommodate a minimum of six (6) standard sized motor vehicles.
- 3) Enhanced landscaping shall be provided in the north-west property corner to provide additional screening for the adjacent residential. This screening shall be approved by the Planning and Zoning Commission in conjunction with the site plan submittal for the proposed development depicted in *Exhibit 'B'*.

2.2 COMPLIANCE

Approval of this ordinance in accordance with Subsection 02.02, *Specific Use Permits (SUP)*, of Article 11, *Development Applications and Review Procedures*, of the Unified Development Code (UDC) will require the *Subject Property* to comply with the following:

- 1) Upon obtaining a *Certificate of Occupancy (CO)*, should the business owner operating under the guidelines of this ordinance fail to meet the minimum operational requirements set forth herein and outlined in the Unified Development Code (UDC), the City may (after proper notice) initiate proceedings to revoke the Specific Use Permit (SUP) in accordance with Subsection 02.02(F), *Revocation*, of Article 11, *Development Applications and Review Procedures*, of the Unified Development Code (UDC) [*Ordinance No. 20-02*].

SECTION 3. That the official zoning map of the City be corrected to reflect the changes in zoning described herein.

SECTION 4. That all ordinances of the City of Rockwall in conflict with the provisions of this ordinance be, and the same are hereby repealed to the extent of that conflict.

SECTION 5. Any person, firm, or corporation violating any of the provisions of this ordinance shall be deemed guilty of a misdemeanor and upon conviction shall be punished by a penalty of fine not to exceed the sum of *TWO THOUSAND DOLLARS (\$2,000.00)* for each offence and each and every day such offense shall continue shall be deemed to constitute a separate offense.

SECTION 6. If any section or provision of this ordinance or the application of that section or provision to any person, firm, corporation, situation or circumstance is for any reason judged invalid, the adjudication shall not affect any other section or provision of this ordinance or the application of any other section or provision to any other person, firm, corporation, situation or circumstance, and the City Council declares that it would have adopted the valid portions and applications of the ordinance without the invalid parts and to this end the provisions of this ordinance shall remain in full force and effect.

SECTION 7. That this ordinance shall take effect immediately from and after its passage.

**PASSED AND APPROVED BY THE CITY COUNCIL OF THE CITY OF ROCKWALL, TEXAS,
THIS THE 2nd DAY OF OCTOBER, 2023.**

Trace Johannesen, Mayor

ATTEST:

Kristy Teague, City Secretary

APPROVED AS TO FORM:

Frank J. Garza, *City Attorney*

1st Reading: September 18, 2023

2nd Reading: October 2, 2023

**Exhibit 'A':
Location Map**

LEGAL DESCRIPTION: Lots 8 & 9, Block A, Dalton-Goliad Addition



Case Location Map = 



City of Rockwall

Planning & Zoning Department
385 S. Goliad Street
Rockwall, Texas 75087
(P): (972) 771-7745
(W): www.rockwall.com

The City of Rockwall GIS maps are continually under development and therefore subject to change without notice. While we endeavor to provide timely and accurate information, we make no guarantees. The City of Rockwall makes no warranty, express or implied, including warranties of merchantability and fitness for a particular purpose. Use of the information is the sole responsibility of the user.



Exhibit 'B': Concept Plan

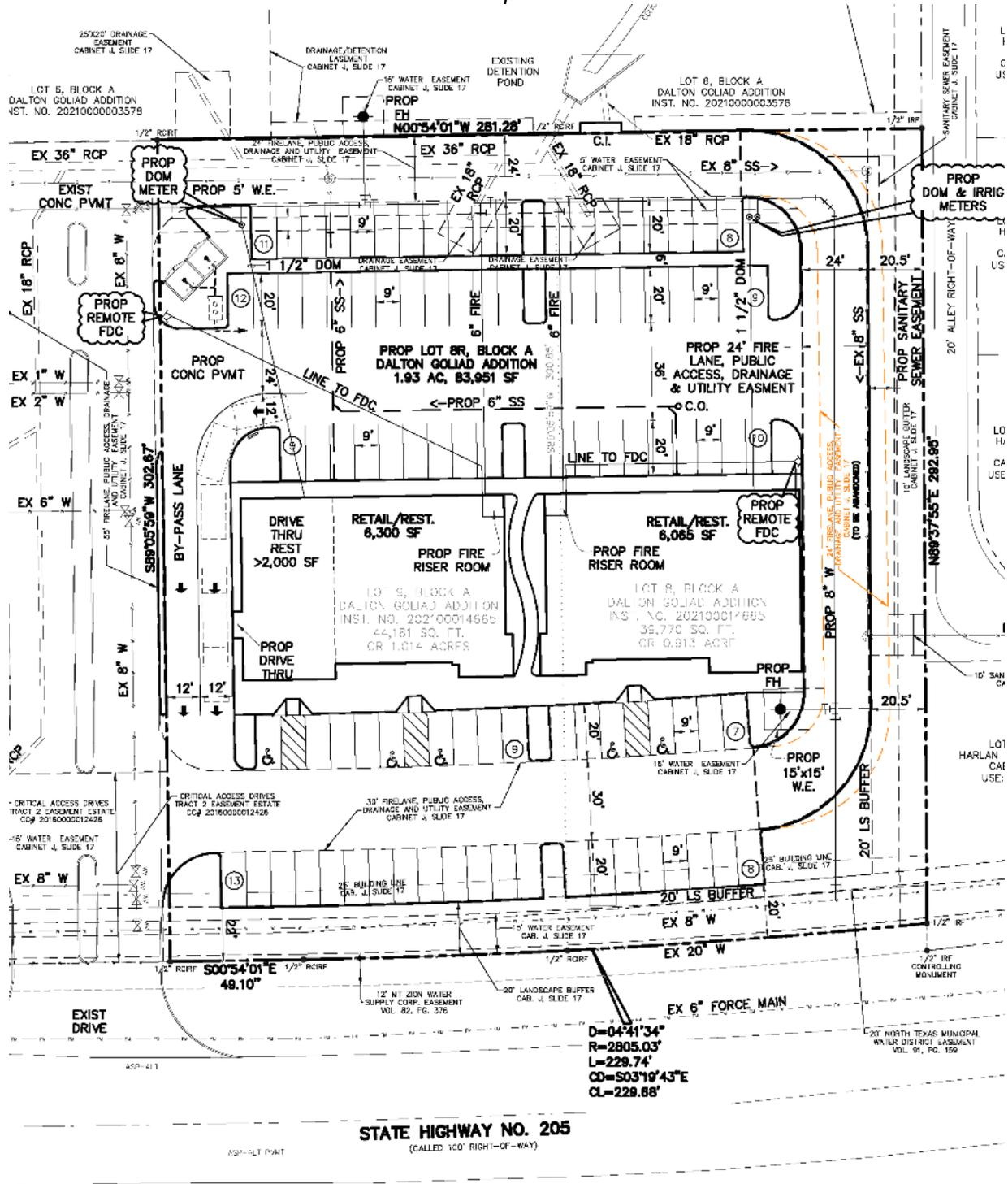

CITY OF ROCKWALL

ORDINANCE NO. 23-58

SPECIFIC USE PERMIT NO. S-317

AN ORDINANCE OF THE CITY COUNCIL OF THE CITY OF ROCKWALL, TEXAS, AMENDING PLANNED DEVELOPMENT DISTRICT 8 (PD-8) [*ORDINANCE NO. 23-40*] AND THE UNIFIED DEVELOPMENT CODE (UDC) [*ORDINANCE NO. 20-02*] OF THE CITY OF ROCKWALL, ROCKWALL COUNTY, TEXAS, AS PREVIOUSLY AMENDED, SO AS TO GRANT A SPECIFIC USE PERMIT (SUP) FOR *RESIDENTIAL INFILL IN AN ESTABLISHED SUBDIVISION* TO ALLOW THE CONSTRUCTION OF A SINGLE-FAMILY HOME ON A 0.1519-ACRE PARCEL OF LAND, IDENTIFIED AS LOT 18, BLOCK B, OF THE HARBOR LANDING PHASE 2 ADDITION, CITY OF ROCKWALL, ROCKWALL COUNTY, TEXAS; AND MORE SPECIFICALLY DESCRIBED AND DEPICTED IN *EXHIBIT 'A'* OF THIS ORDINANCE; PROVIDING FOR SPECIAL CONDITIONS; PROVIDING FOR A PENALTY OF FINE NOT TO EXCEED THE SUM OF TWO THOUSAND DOLLARS (\$2,000.00) FOR EACH OFFENSE; PROVIDING FOR A SEVERABILITY CLAUSE; PROVIDING FOR A REPEALER CLAUSE; PROVIDING FOR AN EFFECTIVE DATE.

WHEREAS, the City has received a request by Angelina Nguyen for the approval of a *Specific Use Permit (SUP)* for *Residential Infill in an Established Subdivision* for the purpose of constructing a single-family home on a 0.1519-acre parcel of land identified as Lot 18, Block B, of the Harbor Landing Phase 2 Addition, City of Rockwall, Rockwall County, Texas, zoned Planned Development District 8 (PD-8) [*Ordinance No. 23-40*] for Single-Family 7 (SF-7) District land uses, addressed as 303 Harborview Drive, and being more specifically described and depicted in *Exhibit 'A'* of this ordinance, which herein after shall be referred to as the *Subject Property* and incorporated by reference herein; and

WHEREAS, the Planning and Zoning Commission of the City of Rockwall and the governing body of the City of Rockwall, in compliance with the laws of the State of Texas and the ordinances of the City of Rockwall, have given the requisite notices by publication and otherwise, and have held public hearings and afforded a full and fair hearing to all property owners generally, and to all persons interested in and situated in the affected area and in the vicinity thereof, the governing body in the exercise of its legislative discretion has concluded that Planned Development District 8 (PD-8) [*Ordinance No. 23-40*] and the Unified Development Code (UDC) [*Ordinance No. 20-02*] of the City of Rockwall should be amended as follows:

NOW, THEREFORE, BE IT ORDAINED by the City Council of the City of Rockwall, Texas;

SECTION 1. That Planned Development District 8 (PD-8) [*Ordinance No. 23-40*] and the Unified Development Code (UDC) [*Ordinance No. 20-02*] of the City of Rockwall, as heretofore amended, be and the same is hereby amended so as to grant a Specific Use Permit (SUP) for *Residential Infill in an Established Subdivision* to allow for the construction of a single-family home in an established subdivision in accordance with Article 04, *Permissible Uses*, of the Unified Development Code (UDC) [*Ordinance No. 20-02*] on the *Subject Property*; and,

SECTION 2. That the Specific Use Permit (SUP) shall be subject to the requirements set forth in Planned Development District 8 (PD-8) [*Ordinance No. 23-40*] and Subsection 03.01, *General Residential District Standards*, of Article 05, *District Development Standards*, of the Unified Development Code (UDC) [*Ordinance No. 20-02*] -- as heretofore amended and may be amended in the future -- and with the following conditions:

2.1 OPERATIONAL CONDITIONS

The following conditions pertain to the construction of a single-family home on the *Subject Property* and conformance to these operational conditions are required:

- 1) The development of the *Subject Property* shall generally conform to the *Residential Plot Plan* as depicted in *Exhibit 'A'* of this ordinance.
- 2) The construction of a single-family home on the *Subject Property* shall generally conform to the *Building Elevations* depicted in *Exhibit 'B'* of this ordinance.
- 3) Once construction of the single-family home has been completed, inspected, and accepted by the City of Rockwall, this Specific Use Permit (SUP) shall expire, and no further action by the property owner shall be required.

2.2 COMPLIANCE

Approval of this ordinance in accordance with Subsection 02.02, *Specific Use Permits (SUP)* of Article 11, *Development Applications and Review Procedures*, of the Unified Development Code (UDC) will require the *Subject Property* to comply with the following:

- 1) Upon obtaining a *Building Permit*, should the contractor operating under the guidelines of this ordinance fail to meet the minimum operational requirements set forth herein and outlined in the Unified Development Code (UDC), the City may (*after proper notice*) initiate proceedings to revoke the Specific Use Permit (SUP) in accordance with Subsection 02.02(F), *Revocation*, of Article 11, *Development Applications and Revision Procedures*, of the Unified Development Code (UDC) [*Ordinance No. 20-02*].

SECTION 3. That the official zoning map of the City be corrected to reflect the changes in zoning described herein.

SECTION 4. That all ordinances of the City of Rockwall in conflict with the provisions of this ordinance be, and the same are hereby repealed to the extent of that conflict.

SECTION 5. Any person, firm, or corporation violating any of the provisions of this ordinance shall be deemed guilty of a misdemeanor and upon conviction shall be punished by a penalty of fine not to exceed the sum of *TWO THOUSAND DOLLARS (\$2,000.00)* for each offence and each and every day such offense shall continue shall be deemed to constitute a separate offense.

SECTION 6. If any section or provision of this ordinance or the application of that section or provision to any person, firm, corporation, situation or circumstance is for any reason judged invalid, the adjudication shall not affect any other section or provision of this ordinance or the application of any other section or provision to any other person, firm, corporation, situation or circumstance, and the City Council declares that it would have adopted the valid portions and applications of the ordinance without the invalid parts and to this end the provisions of this ordinance shall remain in full

force and effect.

SECTION 7. That this ordinance shall take effect immediately from and after its passage.

**PASSED AND APPROVED BY THE CITY COUNCIL OF THE CITY OF ROCKWALL, TEXAS,
THIS THE 2ND DAY OF OCTOBER, 2023.**

Trace Johannesen, Mayor

ATTEST:

Kristy Teague, City Secretary

APPROVED AS TO FORM:

Frank J. Garza, City Attorney

1st Reading: September 18, 2023

2nd Reading: October 2, 2023

Exhibit 'A':
Location Map and Residential Plot Plan

Address: 303 Harborview Drive

Legal Description: Lot 18, Block B, Harbor Landing Phase 2 Addition



Exhibit 'A':
Location Map and Residential Plot Plan

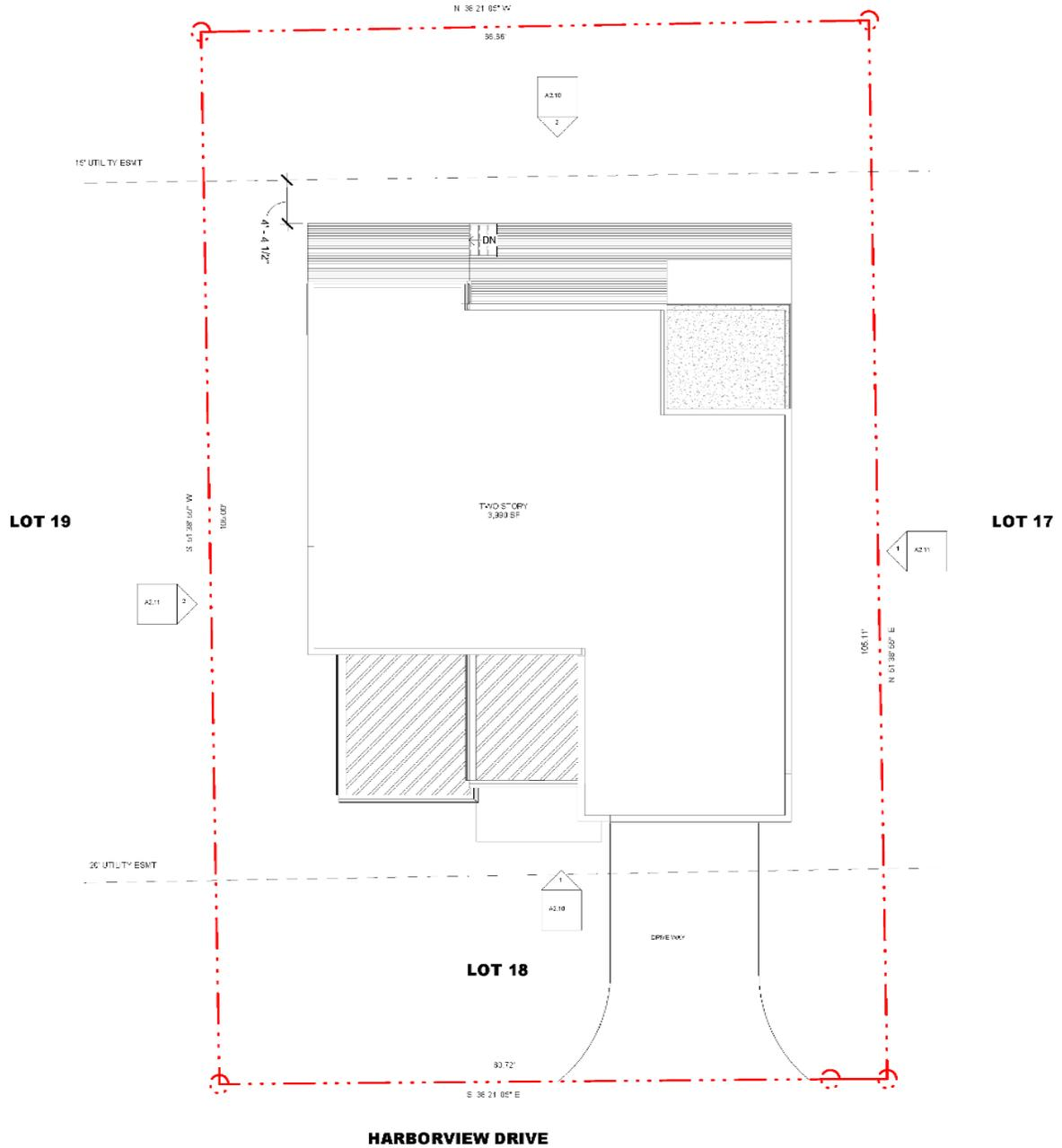
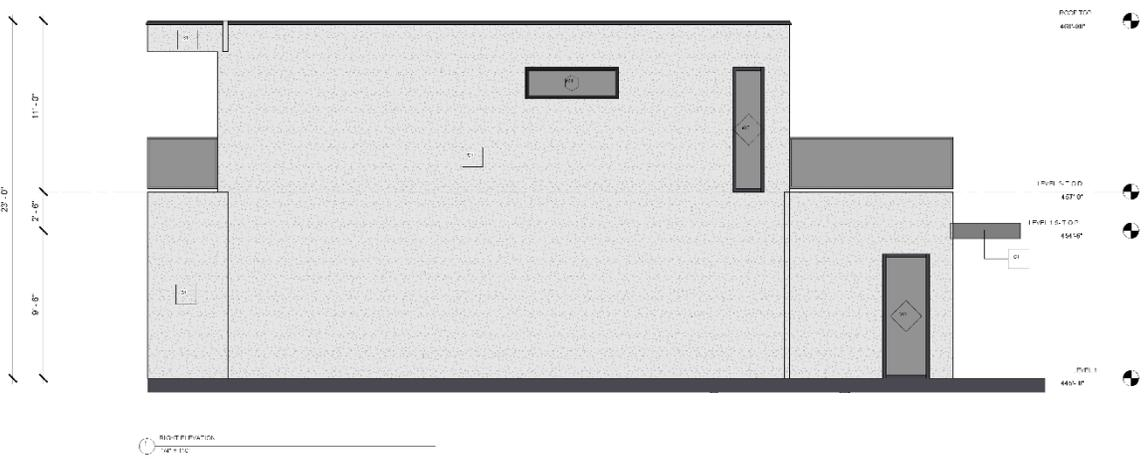

Exhibit 'B':
Building Elevations



Exhibit 'B': Building Elevations



CITY OF ROCKWALL

ORDINANCE NO. 23-59

AN ORDINANCE OF THE CITY COUNCIL OF THE CITY OF ROCKWALL, TEXAS, ("CITY") AMENDING THE CODE OF ORDINANCES OF THE CITY OF ROCKWALL IN CHAPTER 28 TO ESTABLISH A MUNICIPAL COURT OF RECORD; AMENDING ARTICLE I IN GENERAL AND ARTICLE III FEES; DECLARING A PUBLIC PURPOSE; PROVIDING FOR RECITALS; PROVIDING FOR A REPEALER CLAUSE; PROVIDING FOR A SEVERABILITY CLAUSE; AND PROVIDING FOR AN EFFECTIVE DATE.

WHEREAS, the City of Rockwall is a Home Rule Municipality and political subdivision of the State of Texas; and

WHEREAS, the City of Rockwall previously established a Municipal Court, pursuant to Tex. Gov't Code Ann. § 29.002; and

WHEREAS, Texas Government Code Section 30.0003 authorizes the Rockwall City Council to create a municipal court of record to provide a more efficient disposition of cases in the municipality; and

WHEREAS, City Council determines that the creation of a municipal court of record is preferred to provide a more efficient disposition of appeals from municipal cases arising from the City of Rockwall Municipal Court; and

WHEREAS, at this time, City Council desires to establish a municipal court of record.

NOW, THEREFORE BE IT ORDAINED BY THE CITY COUNCIL OF THE CITY OF ROCKWALL, TEXAS THAT:

SECTION 1. The Code of Ordinances of the City of Rockwall, Texas, is hereby amended by revising Chapter 28, Municipal Court of Record, Article I. In General, which shall now read as follows:

CHAPTER 28 MUNICIPAL COURT OF RECORD

Article I. In General

Sec. 28-1. Created.

There is hereby created and established a municipal court of record for the city to be known as the "municipal court."

Sec. 28-2. Jurisdiction.

- (a) The municipal court shall have exclusive original jurisdiction within the territorial limits of the city and property owned by the city located in the city's extraterritorial jurisdiction in all criminal cases arising under the ordinances of the city in which punishment is by fine only and where the maximum of such fine may not exceed:

- (1) \$2,000.00 in all cases arising under ordinances or resolutions, rules, or orders of a joint board that govern fire safety, zoning, or public health and sanitation, including dumping of refuse; or
 - (2) \$500.00 in all other cases arising under a municipal ordinance or a resolution, rule, or order of a joint board.
- (b) The municipal court has concurrent jurisdiction with the justice court of a precinct in which the city is located in all criminal cases arising under state law that arise within the city's territorial limits or property owned by the city located in the city's extraterritorial jurisdiction and that:
- (1) Are punishable only by a fine, as defined in subsection (c) of this section; or
 - (2) Arise under V.T.C.A., Alcoholic Beverage Code ch. 106, and do not include confinement as an authorized sanction.
- (c) In this section, an offense which is punishable by "fine only" is defined as an offense that is punishable by fine and such sanctions, if any, as authorized by statute not consisting of confinement in jail or imprisonment.
- (d) The fact that a conviction in a municipal court has as a consequence the imposition of a penalty or sanction by an agency or entity other than the court, such as a denial, suspension, or revocation of a privilege, does not affect the original jurisdiction of the municipal court.
- (e) The municipal court has jurisdiction in the forfeiture and final judgment of all bail bonds and personal bonds taken in criminal cases of which the court has jurisdiction.
- (f) This section does not affect the powers given exclusively to a joint board operating an airport under V.T.C.A., Transportation Code § 22.074(d).
- (g) The municipal court shall have exclusive appellate jurisdiction within the city's territorial limits in a case arising under V.T.C.A., Transportation Code ch. 707.

Sec. 28-3. Failure to appear.

Any person willfully violating his written promise to appear in municipal court, after a citation having been issued, shall be deemed guilty of a misdemeanor regardless of the disposition of the charge upon which he was originally arrested.

Sec. 28-4. Court Reporter

- (a) The Municipal Court Clerk may appoint a court reporter who must meet the qualifications provided by law for official court reporters. The court reporter may use written notes, transcribing equipment, video or audio recording equipment, or a combination of those methods to record the proceedings of the Court. The court reporter is not required to record testimony in any case unless the Judge or one of the parties requests a record in writing, and files the request with the Court before trial.
- (b) A court reporter is not required to be present during proceedings of the Municipal Court of Record, provided that proceedings required to be recorded by this section are recorded by a good quality electronic recording device. If a record is made, it shall be kept for the 30-day period, beginning the day after the last day of the court proceeding, trial or denial of motion for new trial, whichever occurs last. If a case is appealed, the proceedings shall be transcribed from the recording by an official court reporter.

Secs. 28-5—28-24. – Reserved

Article III. Fees

Sec. 28-63. Court Reporter Fees

- (a) In the event a case is appealed from the Municipal Court, the following costs shall be paid:
 1. For preparation of the Clerk's record, \$25. The preparation fee does not include the fee for an actual transcription of the proceedings.
 2. The defendant shall pay the fee for the preparation of the Clerk's record, and the fee for an actual transcription of the proceedings.

Secs. 28-64—28-82. – Reserved

SECTION 2. PUBLIC PURPOSE. The City Council expressly finds that the amendment of code by the creation of a municipal court of record is necessary to provide a more efficient disposition of the cases arising in the municipality.

SECTION 3. INCORPORATION OF RECITALS. The City Council finds the recitals contained in the preamble to this ordinance are true and correct and incorporates them as findings of fact.

SECTION 4. REPEALER. All ordinances, resolutions, and code sections in conflict herewith are repealed to the extent of such conflict. The municipal court established pursuant to the general law is abolished in the manner prescribed thereby and all pending cases transferred to said court which shall assume jurisdiction thereof.

SECTION 5. SEVERABILITY. If any provision of this code is found by a court of competent jurisdiction to be invalid or unconstitutional, or if the application of this code to any person or circumstances is found to be invalid or unconstitutional, such invalidity or unconstitutionality shall not affect the other provisions or applications of this code which can be given effect without the invalid or unconstitutional provision or application.

SECTION 6. EFFECTIVE DATE. This ordinance shall be effective immediately following its passage and approval by the City Council.

PASSED AND APPROVED BY THE CITY COUNCIL OF THE CITY OF ROCKWALL, TEXAS, THIS THE 2nd DAY OF OCTOBER, 2023.

Trace Johannesen, Mayor

ATTEST:

Kristy Teague, City Secretary

1st Reading: September 18, 2023

2nd Reading: October 2, 2023

APPROVED AS TO FORM:

Frank J. Garza, City Attorney



CITY OF ROCKWALL
CITY COUNCIL MEMORANDUM

PLANNING AND ZONING DEPARTMENT
385 S. GOLIAD STREET • ROCKWALL, TX 75087
PHONE: (972) 771-7745 • EMAIL: PLANNING@ROCKWALL.COM

TO: Mayor and City Council
DATE: October 2, 2023
APPLICANT: Ashley Egan
CASE NUMBER: P2023-030; *Final Plat for Lot 1 Block A, Reborn Skin Addition*

SUMMARY

Consider a request by Ashley Egan for the approval of a Final Plat for Lot 1, Block A, Reborn Skin Addition being a 0.51-acre tract of land identified as Block 80B, B.F. Boydston Addition, City of Rockwall, Rockwall County, Texas, zoned Residential-Office (RO) District, addressed as 108 St. Mary's Street, and take any action necessary.

PLAT INFORMATION

- Purpose. The applicant is requesting the approval of a Final Plat for a 0.51-acre parcel of land (*i.e. Block 80B, B.F. Boydston Addition*) for the purpose of creating one (1) lot (*i.e. Lot 1, Block A, Reborn Skin Addition*) and establishing access, fire lane, and utility easements necessary to convert a single-family home into a 1,182 SF office building.
- Background. The subject property was annexed prior to 1934 based on the August 25, 1934 Sanborn Map. At some point after August 25, 1934 the subject property was platted as Block 80B, B. F. Boydston Addition. According to the City's historic zoning maps, the subject property was zoned Single-Family 3 (SF-3) District as of January 3, 1972. This designation changed between January 4, 1972 and May 15, 1983 to a Single-Family 7 (SF-7) District based on the May 16, 1983 zoning map. According to the Rockwall Central Appraisal District (RCAD), the 1,280 SF single-family home situated on the subject property was constructed in 1980. On April 2, 2018, the City Council approved a zoning change [Case No. Z2018-007] for the subject property from Single-Family (SF-7) District to Residential-Office (RO) District. On February 12, 2019, the Planning and Zoning Commission approved a site plan [Case No. SP2019-002] to allow the conversion of the existing single-family home into a 1,182 SF office building. On June 15, 2021, the Planning and Zoning Commission approved an amended site plan [Case No. SP2021-014]; however, the applicant of this case did not make the improvements required by the approved site plan, and no changes have been made to the subject property since it was originally utilized as a single-family home. On May 9, 2023, the Planning and Zoning Commission approved an amended site plan [Case No. SP2023-014] to allow the conversion of the existing single-family home into a 1,182 SF office building.
- Conformance to the Subdivision Ordinance. The surveyor has completed the majority of the technical revisions requested by staff, and this plat -- *conforming to the requirements for plats as stipulated by the Chapter 38, Subdivisions, of the Municipal Code of Ordinances* -- is recommended for conditional approval pending the completion of final technical modifications and submittal requirements.
- Conditional Approval. Conditional approval of this Final Plat by the City Council shall constitute approval subject to the conditions stipulated in the *Conditions of Approval* section below.

CONDITIONS OF APPROVAL

If the City Council chooses to approve the Final Plat for Lot 1, Block A, Reborn Skin Addition staff would propose the following conditions of approval:

- (1) All technical comments from the Engineering, Planning and Fire Departments shall be addressed prior to the filing of this Final Plat; and,

- (2) Any construction resulting from the approval of this Final Plat shall conform to the requirements set forth by the Unified Development Code (UDC), the International Building Code (IBC), the Rockwall Municipal Code of Ordinances, city adopted engineering and fire codes and with all other applicable regulatory requirements administered and/or enforced by the state and federal government.

PLANNING AND ZONING COMMISSION

On September 26, 2023, the Planning and Zoning Commission approved the Final Plat by a vote of 6-0, with Chairman Deckard absent.



DEVELOPMENT APPLICATION

City of Rockwall
Planning and Zoning Department
385 S. Goliad Street
Rockwall, Texas 75087

STAFF USE ONLY

PLANNING & ZONING CASE NO. _____

NOTE: THE APPLICATION IS NOT CONSIDERED ACCEPTED BY THE CITY UNTIL THE PLANNING DIRECTOR AND CITY ENGINEER HAVE SIGNED BELOW.

DIRECTOR OF PLANNING: _____

CITY ENGINEER: _____

PLEASE CHECK THE APPROPRIATE BOX BELOW TO INDICATE THE TYPE OF DEVELOPMENT REQUEST [SELECT ONLY ONE BOX]:

<p>PLATTING APPLICATION FEES:</p> <p><input type="checkbox"/> MASTER PLAT (\$100.00 + \$15.00 ACRE) ¹</p> <p><input type="checkbox"/> PRELIMINARY PLAT (\$200.00 + \$15.00 ACRE) ¹</p> <p><input checked="" type="checkbox"/> FINAL PLAT (\$300.00 + \$20.00 ACRE) ¹</p> <p><input type="checkbox"/> REPLAT (\$300.00 + \$20.00 ACRE) ¹</p> <p><input type="checkbox"/> AMENDING OR MINOR PLAT (\$150.00)</p> <p><input type="checkbox"/> PLAT REINSTATEMENT REQUEST (\$100.00)</p> <p>SITE PLAN APPLICATION FEES:</p> <p><input type="checkbox"/> SITE PLAN (\$250.00 + \$20.00 ACRE) ¹</p> <p><input type="checkbox"/> AMENDED SITE PLAN/ELEVATIONS/LANDSCAPING PLAN (\$100.00)</p>	<p>ZONING APPLICATION FEES:</p> <p><input type="checkbox"/> ZONING CHANGE (\$200.00 + \$15.00 ACRE) ¹</p> <p><input type="checkbox"/> SPECIFIC USE PERMIT (\$200.00 + \$15.00 ACRE) ^{1&2}</p> <p><input type="checkbox"/> PD DEVELOPMENT PLANS (\$200.00 + \$15.00 ACRE) ¹</p> <p>OTHER APPLICATION FEES:</p> <p><input type="checkbox"/> TREE REMOVAL (\$75.00)</p> <p><input type="checkbox"/> VARIANCE REQUEST/SPECIAL EXCEPTIONS (\$100.00) ²</p> <p>NOTES:</p> <p>¹: IN DETERMINING THE FEE, PLEASE USE THE EXACT ACREAGE WHEN MULTIPLYING BY THE PER ACRE AMOUNT. FOR REQUESTS ON LESS THAN ONE ACRE, ROUND UP TO ONE (1) ACRE.</p> <p>²: A \$1,000.00 FEE WILL BE ADDED TO THE APPLICATION FEE FOR ANY REQUEST THAT INVOLVES CONSTRUCTION WITHOUT OR NOT IN COMPLIANCE TO AN APPROVED BUILDING PERMIT.</p>
--	---

PROPERTY INFORMATION [PLEASE PRINT]

ADDRESS: 108 Saint Mary St. Rockwall, TX 75087

SUBDIVISION: B.F. Boydston LOT: 1 BLOCK: _____

GENERAL LOCATION: near St. Mary St and S. Funnin St.

ZONING, SITE PLAN AND PLATTING INFORMATION [PLEASE PRINT]

CURRENT ZONING: Mixed use CURRENT USE: office (vacant)

PROPOSED ZONING: mixed use PROPOSED USE: office

ACREAGE: 0.51 LOTS [CURRENT]: 1 LOTS [PROPOSED]: _____

SITE PLANS AND PLATS: BY CHECKING THIS BOX YOU ACKNOWLEDGE THAT DUE TO THE PASSAGE OF HB3167 THE CITY NO LONGER HAS FLEXIBILITY WITH REGARD TO ITS APPROVAL PROCESS, AND FAILURE TO ADDRESS ANY OF STAFF'S COMMENTS BY THE DATE PROVIDED ON THE DEVELOPMENT CALENDAR WILL RESULT IN THE DENIAL OF YOUR CASE.

OWNER/APPLICANT/AGENT INFORMATION [PLEASE PRINT/CHECK THE PRIMARY CONTACT/ORIGINAL SIGNATURES ARE REQUIRED]

<input checked="" type="checkbox"/> OWNER	<u>Ashley Egan</u>	<input type="checkbox"/> APPLICANT	_____
CONTACT PERSON	<u>Justine Jones</u>	CONTACT PERSON	_____
ADDRESS	<u>109 Saint Mary St.</u>	ADDRESS	_____
CITY, STATE & ZIP	<u>Rockwall, TX 75087</u>	CITY, STATE & ZIP	_____
PHONE	<u>(509) 630-1392</u>	PHONE	_____
E-MAIL	_____	E-MAIL	_____

NOTARY VERIFICATION [REQUIRED]

BEFORE ME, THE UNDERSIGNED AUTHORITY, ON THIS DAY PERSONALLY APPEARED Ashley Egan [OWNER] THE UNDERSIGNED, WHO STATED THE INFORMATION ON THIS APPLICATION TO BE TRUE AND CERTIFIED THE FOLLOWING:

"I HEREBY CERTIFY THAT I AM THE OWNER FOR THE PURPOSE OF THIS APPLICATION; ALL INFORMATION SUBMITTED HEREIN IS TRUE AND CORRECT; AND THE APPLICATION FEE OF \$ _____ TO COVER THE COST OF THIS APPLICATION, HAS BEEN PAID TO THE CITY OF ROCKWALL ON THIS THE 13th DAY OF September, 2022 BY SIGNING THIS APPLICATION, I AGREE THAT THE CITY OF ROCKWALL (I.E. "CITY") IS AUTHORIZED AND PERMITTED TO PROVIDE INFORMATION CONTAINED WITHIN THIS APPLICATION TO THE PUBLIC. THE CITY IS ALSO AUTHORIZED AND PERMITTED TO REPRODUCE ANY COPYRIGHTED INFORMATION SUBMITTED IN CONJUNCTION WITH THIS APPLICATION, IF SUCH REPRODUCTION IS ASSOCIATED OR IN RESPONSE TO A REQUEST FOR PUBLIC INFORMATION."

GIVEN UNDER MY HAND AND SEAL OF OFFICE ON THIS THE 9th DAY OF September, 2022.

OWNER'S SIGNATURE

[Handwritten Signature]

NOTARY PUBLIC IN AND FOR THE STATE OF TEXAS

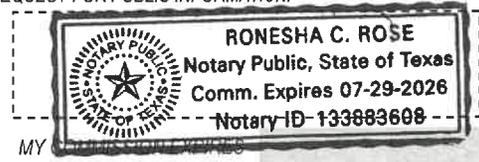

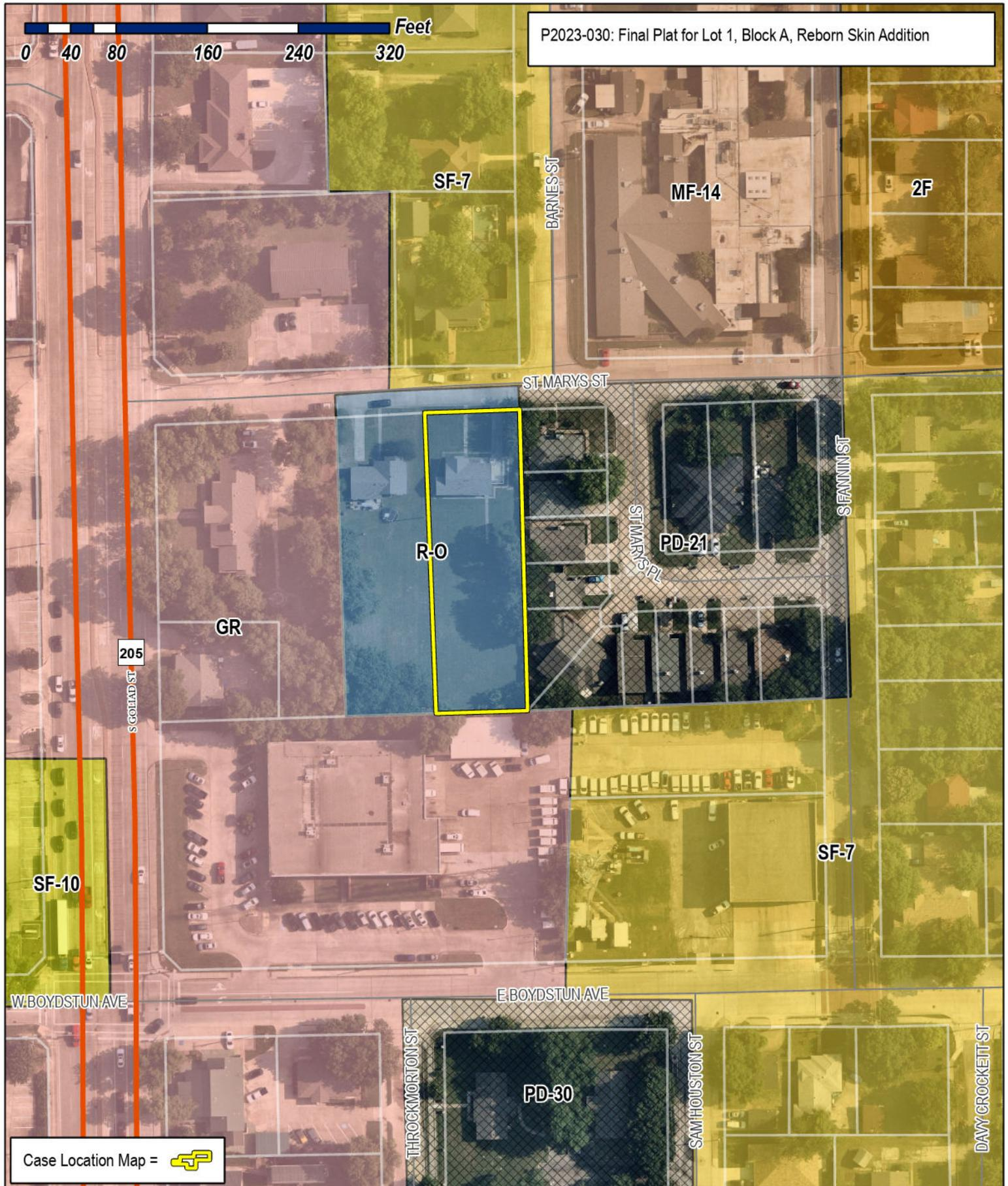

P2023-030: Final Plat for Lot 1, Block A, Reborn Skin Addition

0 40 80 160 240 320 Feet

Case Location Map =



City of Rockwall

Planning & Zoning Department
 385 S. Goliad Street
 Rockwall, Texas 75087
 (P): (972) 771-7745
 (W): www.rockwall.com

The City of Rockwall GIS maps are continually under development and therefore subject to change without notice. While we endeavor to provide timely and accurate information, we make no guarantees. The City of Rockwall makes no warranty, express or implied, including warranties of merchantability and fitness for a particular purpose. Use of the information is the sole responsibility of the user.



OWNER'S CERTIFICATE
(Public Dedication)

STATE OF TEXAS
COUNTY OF ROCKWALL

WHEREAS, ASHLEY EGAN, Being the owners of a tract of land in the County of Rockwall, State of Texas, said tract being described as follows:

All that certain lot, tract or parcel of land situated in the B.F. BOYDSTUN SURVEY, ABSTRACT NO. 14, City of Rockwall, Rockwall County, Texas, and being all of a tract of land as described in a Warranty deed to T & C Mainstreet Holdings, LLC, as recorded in Document no. 2018000011235 of the Official Public Records of Rockwall County, Texas, and being more particularly described as follows:

BEGINNING at a 1/2" iron rod found for corner in the south right-of-way of St. Marys Street, a variable width right-of-way approximately 40 feet existing in width, and being at the northeast corner of the above cited tract and at the northwest corner of Lot 1, Block 1, St Mary's Place Addition, an Addition to the City of Rockwall, Texas, according to the Plat thereof recorded in Cabinet B, Slide 40 of the Plat Records of Rockwall County, Texas;

THENCE S. 01 deg. 01 min. 44 sec. E. along the west boundary line of said Addition, a distance of 262.27 feet to 1/2" iron rod found for corner in the north boundary line of Rockwall Main Post Office Addition, an Addition to the City of Rockwall, Texas, according to the Plat thereof recorded in Cabinet B, Slide 369 of the Plat Records of Rockwall County, Texas;

THENCE S. 88 deg. 40min. 09 sec. W. along the north boundary line of said Rockwall Main Post Office Addition, a distance of 85.09 feet to 1/2" iron rod found for corner at the southwest corner of said T & C Mainstreet tract;

THENCE N. 00 deg. 59 min. 00 sec. W. a distance of 262.40 feet to a 1/2" iron rod found for corner in the south right-of-way line of St Marys Street;

THENCE N. 88 deg. 45 min. 18 sec. E. along said right-of-way line, a distance of 84.89 feet to the POINT OF BEGINNING and containing 22,296 square feet or 0.51 acres of land.

NOW, THEREFORE, KNOW ALL MEN BY THESE PRESENTS:

STATE OF TEXAS
COUNTY OF ROCKWALL

I the undersigned owner of the land shown on this plat, and designated herein as REBORN SKIN ADDITION, Lot 1, Block A, an Addition to the City of Rockwall, Texas, and whose name is subscribed hereto, hereby dedicate to the use of the public forever all streets, alleys, parks, water courses, drains, easements and public places thereon shown on the purpose and consideration therein expressed. I further certify that all other parties who have a mortgage or lien interest in REBORN SKIN ADDITION, Lot 1, Block A, have been notified and signed this plat.

I understand and do hereby reserve the easement strips shown on this plat for the purposes stated and for the mutual use and accommodation of all utilities desiring to use or using same.

I also understand the following:

- No buildings shall be constructed or placed upon, over, or across the utility easements as described herein.
- Any public utility shall have the right to remove and keep removed all or part of any buildings, fences, trees, shrubs, or other growths or improvements which in any way endanger or interfere with construction, maintenance or efficiency of their respective system on any of these easement strips; and any public utility shall at all times have the right of ingress or egress to, from and upon the said easement strips for purpose of construction, reconstruction, inspecting, patrolling, maintaining, and either adding to or removing all or part of their respective system without the necessity of, at any time, procuring the permission of anyone.
- The City of Rockwall will not be responsible for any claims of any nature resulting from or occasioned by the establishment of grade of streets in the subdivision.
- The developer and subdivision engineer shall bear total responsibility for storm drain improvements.
- The developer shall be responsible for the necessary facilities to provide drainage patterns and drainage controls such that properties within the drainage area are not adversely affected by storm drainage from the development.
- No house dwelling unit, or other structure shall be constructed on any lot in this addition by the owner or any other person until the developer and/or owner has complied with all requirements of the Subdivision Regulations of the City of Rockwall regarding improvements with respect to the entire block on the street or streets on which property abuts, including the actual installation of streets with the required base and paving, curb and gutter, water and sewer, drainage structures, storm structures, storm sewers, and alleys, all according to the specifications of the City of Rockwall; or
Until an escrow deposit, sufficient to pay for the cost of such improvements, as determined by the city's engineer and/or city administrator, computed on a private commercial rate basis, has been made with the city secretary, accompanied by an agreement signed by the developer and/or owner, authorizing the city to make such improvements at prevailing private commercial rates or have the same made by a contractor and pay for the same out of the escrow deposit, should the developer and/or owner fail or refuse to install the required improvements within the time stated in such written agreement, but in no case shall the City be obligated to make such improvements itself. Such deposit may be used by the owner and/or developer as progress payments as the work progresses in making such improvements by making certified requisitions to the city secretary, supported by evidence of work done; or

Until the developer and/or owner files a corporate surety bond with the city secretary in a sum equal to the cost of such improvements for the designated area, guaranteeing the installation thereof within the time stated in the bond, which time shall be fixed by the city council of the City of Rockwall.

I further acknowledge that the dedications and/or exaction's made herein are proportional to the impact of the subdivision upon the public services required in order that the development will comport with the present and future growth needs of the City; I, my successors and assigns hereby waive any claim, damage, or cause of action that I may have as a result of the dedication of exaction's made herein.

ASHLEY EGAN _____

STATE OF TEXAS
COUNTY OF ROCKWALL

Before me, the undersigned authority, on this day personally appeared ASHLEY EGAN known to me to be the person whose name is subscribed to the foregoing instrument, and acknowledged to me that he executed the same for the purpose and consideration therein stated.
Given upon my hand and seal of office this _____ day of _____, _____.

Notary Public in and for the State of Texas _____ My Commission Expires: _____

NOTE: It shall be the policy of the City of Rockwall to withhold issuing building permits until all streets, water, sewer and storm drainage systems have been accepted by the City. The approval of a plat by the City does not constitute any representation, assurance or guarantee that any building within such plat shall be approved, authorized or permit therefore issued, as required under Ordinance 83-54.

SURVEYOR'S CERTIFICATE

NOW, THEREFORE KNOW ALL MEN BY THESE PRESENTS:

THAT I, Harold D. Fetty, III, R.P.L.S. No. 5034, do hereby certify that I prepared this plat from an actual and accurate survey of the land, and that the corner monuments shown thereon were properly placed under my personal supervision.



Harold D. Fetty, III
Registered Professional Land Surveyor No. 5034

RECOMMENDED FOR FINAL APPROVAL

Planning and Zoning Commission _____ Date _____

APPROVED

I hereby certify that the above and foregoing plat of T & C ADDITION, Lot 1, Block A, an addition to the City of Rockwall, Texas, an addition to the City of Rockwall, Texas, was approved by the City Council of the City of Rockwall on the _____ day of _____, _____.

This approval shall be invalid unless the approved plat for such addition is recorded in the office of the County Clerk of Rockwall, County, Texas, within one hundred eighty (180) days from said date of final approval.

Said addition shall be subject to all the requirements of the Subdivision Regulations of the City of Rockwall.

WITNESS OUR HANDS, this _____ day of _____, _____.

Mayor, City of Rockwall _____

City Secretary City of Rockwall _____

City Engineer _____

Date _____

FINAL PLAT
**REBORN SKIN ADDITION
LOT 1, BLOCK A**

0.51 ACRES OR 22,296 S.F.
(1 LOT)
B.F. BOYDSTUN SURVEY, A-14
CITY OF ROCKWALL, ROCKWALL COUNTY, TEXAS

SHEET 2 OF 2

OWNER:
ASHLEY EGAN
109 SAINT MARY STREET
ROCKWALL, TEXAS 75087

SYMBOL LEGEND	
⊙	WATER MAIN
⊙	WATER SERVICE LINE
⊙	SEWER MAIN
⊙	SEWER SERVICE LINE
⊙	TELEPHONE MAIN
⊙	TELEPHONE SERVICE LINE
⊙	ELECTRIC MAIN
⊙	ELECTRIC SERVICE LINE
⊙	STORM MAIN
⊙	STORM SERVICE LINE
⊙	IRRIGATION MAIN
⊙	IRRIGATION SERVICE LINE
⊙	POWER POLE
⊙	HYDRANT
⊙	WATER METER
⊙	SEWER METER
⊙	TELEPHONE METER
⊙	ELECTRIC METER
⊙	STORM METER
⊙	IRRIGATION METER
⊙	WATER VALVE
⊙	SEWER VALVE
⊙	TELEPHONE VALVE
⊙	ELECTRIC VALVE
⊙	STORM VALVE
⊙	IRRIGATION VALVE
⊙	WATER MAIN JUNCTION BOX
⊙	SEWER MAIN JUNCTION BOX
⊙	TELEPHONE MAIN JUNCTION BOX
⊙	ELECTRIC MAIN JUNCTION BOX
⊙	STORM MAIN JUNCTION BOX
⊙	IRRIGATION MAIN JUNCTION BOX
⊙	WATER MAIN TIE
⊙	SEWER MAIN TIE
⊙	TELEPHONE MAIN TIE
⊙	ELECTRIC MAIN TIE
⊙	STORM MAIN TIE
⊙	IRRIGATION MAIN TIE
⊙	WATER MAIN TIE
⊙	SEWER MAIN TIE
⊙	TELEPHONE MAIN TIE
⊙	ELECTRIC MAIN TIE
⊙	STORM MAIN TIE
⊙	IRRIGATION MAIN TIE
⊙	WATER MAIN TIE
⊙	SEWER MAIN TIE
⊙	TELEPHONE MAIN TIE
⊙	ELECTRIC MAIN TIE
⊙	STORM MAIN TIE
⊙	IRRIGATION MAIN TIE

H.D. Fetty Land Surveyor, LLC

Firm Registration no. 101509-00
6770 FM 1565 ROYSE CITY, TX 75189 972-635-2255 PHONE tracy@hdfetty.com

SURVEY DATE JANUARY 13, 2020
SCALE 1" = 30'
CLIENT MONK

CITY CASE NO P2023-



CITY OF ROCKWALL

MAYOR AND CITY COUNCIL MEMORANDUM

PLANNING AND ZONING DEPARTMENT

385 S. GOLIAD STREET • ROCKWALL, TX 75087

PHONE: (972) 771-7745 • EMAIL: PLANNING@ROCKWALL.COM

TO: Mayor and City Council

CC: Mary Smith, City Manager
Joey Boyd, Assistant City Manager

FROM: Ryan Miller, *Director of Planning and Zoning*

DATE: October 2, 2023

SUBJECT: SP2023-029; *Alternative Tree Mitigation Settlement Agreement for DuWest*

The applicant, Lynn Rowland of ClayMoore Engineering, is requesting the approval of an *Alternative Tree Mitigation Settlement Agreement*. The subject property is located on an 8.63-acre portion of a larger 36.428-acre tract of land (*i.e. Tract 3 of the S. King Survey, Abstract No. 131*), which is located at the northeast corner of the intersection of E. Quail Run Road and N. Goliad Street [*SH-205*]. On September 26, 2023, the Planning and Zoning Commission approved a *Site Plan* [*Case No. SP2023-029*] and *Treescape Plan* for the development of two (2), ~11,000 SF retail/restaurant buildings on the subject property. As part of this approval, the Planning and Zoning Commission also recommended approval of an *Alternative Tree Mitigation Settlement Agreement*. The *Site Plan*, *Treescape Plan*, and *Alternative Tree Mitigation Settlement Agreement* were approved by the Planning and Zoning Commission by a vote of 6-0, with Commissioner Deckard absent.

The approved *Treescape Plan* indicates that 1,447 caliper inches of trees will be removed from the subject property, and -- *through the landscape plan and a tree preservation credit* -- that the remaining mitigation balance will be 373 caliper inches of trees. Based on this, the applicant is requesting an *Alternative Tree Mitigation Settlement Agreement* in order to pay the remaining tree mitigation balance in full. This equates to \$37,300.00 (*i.e. \$100.00 x 373-inches = \$37,300.00*). Staff should note that the tree preservation credit reduces from \$200.00 per inch to \$100.00 per inch when trees are being added on-site, and in this case the applicant is proposing to plant 121 additional trees on-site. The City Council is charged with acting upon the proposed *Alternative Tree Mitigation Settlement Agreement*. Should the City Council have any questions concerning the applicants request, staff will be available at the meeting on October 2, 2023.



DEVELOPMENT APPLICATION

City of Rockwall
Planning and Zoning Department
385 S. Goliad Street
Rockwall, Texas 75087

STAFF USE ONLY

PLANNING & ZONING CASE NO.

NOTE: THE APPLICATION IS NOT CONSIDERED ACCEPTED BY THE CITY UNTIL THE PLANNING DIRECTOR AND CITY ENGINEER HAVE SIGNED BELOW.

DIRECTOR OF PLANNING:

CITY ENGINEER:

PLEASE CHECK THE APPROPRIATE BOX BELOW TO INDICATE THE TYPE OF DEVELOPMENT REQUEST (SELECT ONLY ONE BOX):

PLATTING APPLICATION FEES:

- MASTER PLAT (\$100.00 + \$15.00 ACRE) ¹
- PRELIMINARY PLAT (\$200.00 + \$15.00 ACRE) ¹
- FINAL PLAT (\$300.00 + \$20.00 ACRE) ¹
- REPLAT (\$300.00 + \$20.00 ACRE) ¹
- AMENDING OR MINOR PLAT (\$150.00)
- PLAT REINSTATEMENT REQUEST (\$100.00)

SITE PLAN APPLICATION FEES:

- SITE PLAN (\$250.00 + \$20.00 ACRE) ¹
- AMENDED SITE PLAN/ELEVATIONS/LANDSCAPING PLAN (\$100.00)

ZONING APPLICATION FEES:

- ZONING CHANGE (\$200.00 + \$15.00 ACRE) ¹
- SPECIFIC USE PERMIT (\$200.00 + \$15.00 ACRE) ^{1 & 2}
- PD DEVELOPMENT PLANS (\$200.00 + \$15.00 ACRE) ¹

OTHER APPLICATION FEES:

- TREE REMOVAL (\$75.00)
- VARIANCE REQUEST/SPECIAL EXCEPTIONS (\$100.00) ²

NOTES:

¹: IN DETERMINING THE FEE, PLEASE USE THE EXACT ACREAGE WHEN MULTIPLYING BY THE PER ACRE AMOUNT. FOR REQUESTS ON LESS THAN ONE ACRE, ROUND UP TO ONE (1) ACRE.
²: A \$1,000.00 FEE WILL BE ADDED TO THE APPLICATION FEE FOR ANY REQUEST THAT INVOLVES CONSTRUCTION WITHOUT OR NOT IN COMPLIANCE TO AN APPROVED BUILDING PERMIT.

PROPERTY INFORMATION [PLEASE PRINT]

ADDRESS **Not Assigned Yet**

SUBDIVISION

LOT

BLOCK

GENERAL LOCATION **NEC C Quail Run Road and 205**

ZONING, SITE PLAN AND PLATTING INFORMATION [PLEASE PRINT]

CURRENT ZONING **PD-70**

CURRENT USE **Vacant**

PROPOSED ZONING **PD-70**

PROPOSED USE **Commercial retail**

ACREAGE **8.684**

LOTS [CURRENT]

LOTS [PROPOSED]

SITE PLANS AND PLATS: BY CHECKING THIS BOX YOU ACKNOWLEDGE THAT DUE TO THE PASSAGE OF HB3167 THE CITY NO LONGER HAS FLEXIBILITY WITH REGARD TO ITS APPROVAL PROCESS, AND FAILURE TO ADDRESS ANY OF STAFF'S COMMENTS BY THE DATE PROVIDED ON THE DEVELOPMENT CALENDAR WILL RESULT IN THE DENIAL OF YOUR CASE.

OWNER/APPLICANT/AGENT INFORMATION [PLEASE PRINT/CHECK THE PRIMARY CONTACT/ORIGINAL SIGNATURES ARE REQUIRED]

OWNER **DuWest Realty, LLC**

APPLICANT **ClayMoore Engineering**

CONTACT PERSON **Bowen Hendrix**

CONTACT PERSON **Lynn Rowland**

ADDRESS **4403 North Central Expressway
Suite 200**

ADDRESS **1903 Central Drive
Suite 406**

CITY, STATE & ZIP **Dallas, Tx 75025**

CITY, STATE & ZIP **Bedford, Tx**

PHONE **214-918-1804**

PHONE **817.281.0572**

E-MAIL **bowen@duwestrealty.com**

E-MAIL **Lynn@claymooreeng.com**

NOTARY VERIFICATION [REQUIRED]

BEFORE ME, THE UNDERSIGNED AUTHORITY, ON THIS DAY PERSONALLY APPEARED Bowen Hendrix [OWNER] THE UNDERSIGNED, WHO STATED THE INFORMATION ON THIS APPLICATION TO BE TRUE AND CERTIFIED THE FOLLOWING:

"I HEREBY CERTIFY THAT I AM THE OWNER FOR THE PURPOSE OF THIS APPLICATION; ALL INFORMATION SUBMITTED HEREIN IS TRUE AND CORRECT; AND THE APPLICATION FEE OF \$ 100 TO COVER THE COST OF THIS APPLICATION, HAS BEEN PAID TO THE CITY OF ROCKWALL ON THIS THE 18 DAY OF August, 2023 BY SIGNING THIS APPLICATION, I AGREE THAT THE CITY OF ROCKWALL (I.E. "CITY") IS AUTHORIZED AND PERMITTED TO PROVIDE INFORMATION CONTAINED WITHIN THIS APPLICATION TO THE PUBLIC. THE CITY IS ALSO AUTHORIZED AND PERMITTED TO REPRODUCE ANY COPYRIGHTED INFORMATION SUBMITTED IN CONJUNCTION WITH THIS APPLICATION, IF SUCH REPRODUCTION IS ASSOCIATED OR IN RESPONSE TO A REQUEST FOR PUBLIC INFORMATION."

GIVEN UNDER MY HAND AND SEAL OF OFFICE ON THIS THE 18 DAY OF August, 2023

OWNER'S SIGNATURE

NOTARY PUBLIC IN AND FOR THE STATE OF TEXAS

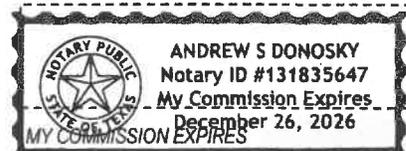



Case Location Map =



City of Rockwall

Planning & Zoning Department
385 S. Goliad Street
Rockwall, Texas 75087
(P): (972) 771-7745
(W): www.rockwall.com

The City of Rockwall GIS maps are continually under development and therefore subject to change without notice. While we endeavor to provide timely and accurate information, we make no guarantees. The City of Rockwall makes no warranty, express or implied, including warranties of merchantability and fitness for a particular purpose. Use of the information is the sole responsibility of the user.



PLOTTED BY: DARCY BRANDON
 PLOT DATE: 8/11/2023 4:20 PM
 C:\USERS\DARCY\DOCUMENTS\DBLA_PROJECTS\2022\EDG\DUWEST - ROCKWALL, TX\DUWEST-ROCKWALL_LP_2023-08-10.DWG
 LOCATION: 8/11/2023 4:20 PM
 LAST SAVED: 8/11/2023 4:20 PM

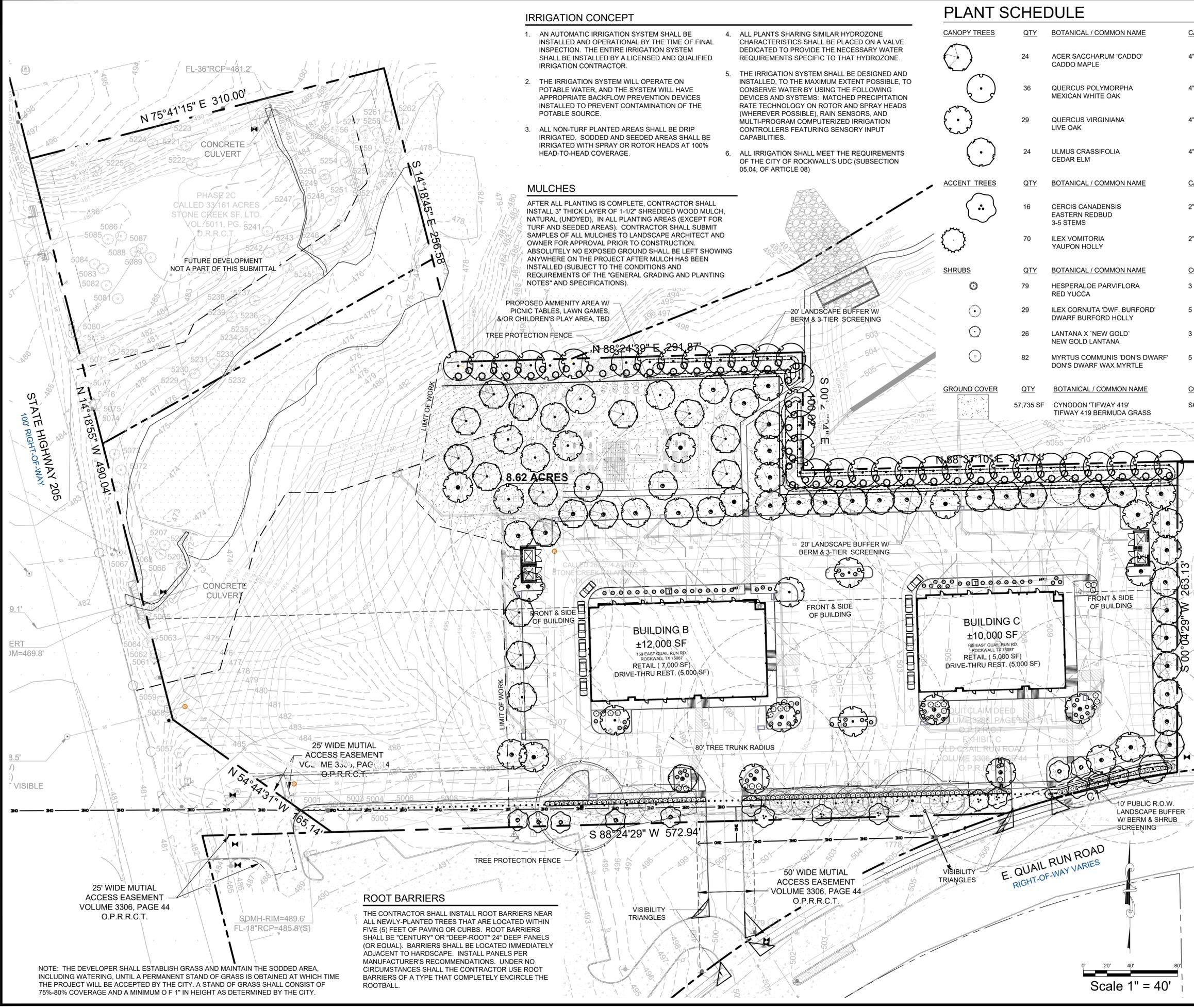

IRRIGATION CONCEPT

1. AN AUTOMATIC IRRIGATION SYSTEM SHALL BE INSTALLED AND OPERATIONAL BY THE TIME OF FINAL INSPECTION. THE ENTIRE IRRIGATION SYSTEM SHALL BE INSTALLED BY A LICENSED AND QUALIFIED IRRIGATION CONTRACTOR.
2. THE IRRIGATION SYSTEM WILL OPERATE ON POTABLE WATER, AND THE SYSTEM WILL HAVE APPROPRIATE BACKFLOW PREVENTION DEVICES INSTALLED TO PREVENT CONTAMINATION OF THE POTABLE SOURCE.
3. ALL NON-TURF PLANTED AREAS SHALL BE DRIP IRRIGATED. SODDED AND SEEDED AREAS SHALL BE IRRIGATED WITH SPRAY OR ROTOR HEADS AT 100% HEAD-TO-HEAD COVERAGE.
4. ALL PLANTS SHARING SIMILAR HYDROZONE CHARACTERISTICS SHALL BE PLACED ON A VALVE DEDICATED TO PROVIDE THE NECESSARY WATER REQUIREMENTS SPECIFIC TO THAT HYDROZONE.
5. THE IRRIGATION SYSTEM SHALL BE DESIGNED AND INSTALLED, TO THE MAXIMUM EXTENT POSSIBLE, TO CONSERVE WATER BY USING THE FOLLOWING DEVICES AND SYSTEMS: MATCHED PRECIPITATION RATE TECHNOLOGY ON ROTOR AND SPRAY HEADS (WHEREVER POSSIBLE), RAIN SENSORS, AND MULTI-PROGRAM COMPUTERIZED IRRIGATION CONTROLLERS FEATURING SENSORY INPUT CAPABILITIES.
6. ALL IRRIGATION SHALL MEET THE REQUIREMENTS OF THE CITY OF ROCKWALL'S UDC (SUBSECTION 05.04, OF ARTICLE 08)

MULCHES

AFTER ALL PLANTING IS COMPLETE, CONTRACTOR SHALL INSTALL 3" THICK LAYER OF 1-1/2" SHREDDED WOOD MULCH, NATURAL (UNDYED), IN ALL PLANTING AREAS (EXCEPT FOR TURF AND SEEDED AREAS). CONTRACTOR SHALL SUBMIT SAMPLES OF ALL MULCHES TO LANDSCAPE ARCHITECT AND OWNER FOR APPROVAL PRIOR TO CONSTRUCTION. ABSOLUTELY NO EXPOSED GROUND SHALL BE LEFT SHOWING ANYWHERE ON THE PROJECT AFTER MULCH HAS BEEN INSTALLED (SUBJECT TO THE CONDITIONS AND REQUIREMENTS OF THE "GENERAL GRADING AND PLANTING NOTES" AND SPECIFICATIONS).

PLANT SCHEDULE

CANOPY TREES	QTY	BOTANICAL / COMMON NAME	CAL	SIZE
	24	ACER SACCHARUM 'CADDO' CADDO MAPLE	4" CAL	16'-18" HT
	36	QUERCUS POLYMORPHA MEXICAN WHITE OAK	4" CAL MIN	14'-16" HT
	29	QUERCUS VIRGINIANA LIVE OAK	4" CAL MIN	14'-16" HT
	24	ULMUS CRASSIFOLIA CEDAR ELM	4" CAL	16'-18" HT
ACCENT TREES	QTY	BOTANICAL / COMMON NAME	CAL	SIZE
	16	CERCIS CANADENSIS EASTERN REDBUD 3-5 STEMS	2" CAL MIN	8' -10' HT
	70	ILEX VOMITORIA YAUPON HOLLY	2" CAL MIN	8' -10' HT
SHRUBS	QTY	BOTANICAL / COMMON NAME	CONT	
	79	HESPERALOE PARVIFLORA RED YUCCA	3 GAL	
	29	ILEX CORNUTA 'DWF. BURFORD' DWARF BURFORD HOLLY	5 GAL	
	26	LANTANA X 'NEW GOLD' NEW GOLD LANTANA	3 GAL	
	82	MYRTUS COMMUNIS 'DON'S DWARF' DON'S DWARF WAX MYRTLE	5 GAL	
GROUND COVER	QTY	BOTANICAL / COMMON NAME	CONT	
	57,735 SF	CYNODON 'TIFWAY 419' TIFWAY 419 BERMUDA GRASS	SOD	



PRELIMINARY
 FOR REVIEW ONLY
 Not for construction purposes.
CLAYMOORE ENGINEERING
 ENGINEERING AND PLANNING CONSULTANTS
 DREW DONOSKY
 P.E. No. 125651, State 8/11/2023

SEE SHEET LP-2 FOR LANDSCAPE STANDARDS

TREE MITIGATION SUMMARY

TOTAL MITIGATION REQUIRED:	865.5"
MITIGATION PROVIDED BY PLANTING 4" CALIPER TREES (107) TO BE PLANTED ONSITE:	428"
MITIGATION PROVIDED BY PURCHASING PRESERVATION CREDITS (20% OF TOTAL): (173.1' x \$200 = \$34,620 PAYMENT INTO THE CITY'S TREE FUND)	173.1"
ALTERNATIVE TREE MITIGATION SETTLEMENT REQUEST (264.4' x \$100 / IN = \$26,440):	264.4"
TOTAL MITIGATION PROVIDED:	865.5"

SITE DATA TABLE

SITE AREA	8.684 AC / 378,275 SF
ZONING	PD-70 (Planned Development) GR (General Retail Dist.)
PROPOSED USE	RETAIL/DRIVE-THRU RESTAURANT
BUILDING SIZE	BLDG. B - 10,000 SF BLDG. C - 10,000 SF
PATIO AREA	2,777 SF
LOT COVERAGE	5.2%
FLOOR AREA RATIO	0.05-1
BUILDING HEIGHT	1-STORY
IMPERVIOUS AREA	116,406 SF (30.8%)
OPEN SPACE	6.04 AC (69.2%)

PARKING DATA TABLE

PARKING REQUIRED	
RETAIL (10,000 SF) 1 SPACE / 250 SF	40 SPACES
DRIVE-THRU RESTAURANT (10,000 SF) 1 SPACE / 100 SF	100 SPACES
PATIO (2,777 SF) 1 SPACE / 100 SF	28 SPACES
TOTAL PARKING	168 SPACES
ADA PARKING	6 SPACES
PARKING PROVIDED	
TOTAL PARKING	168 SPACES
ADA PARKING	6 SPACES

DUWEST ROCKWALL, TX

LEGAL DESCRIPTION AND OR ADDRESS:
STONE CREEK BALANCE LTD
 ABSTRACT, NO 131
 8.684 AC (378,275 SF)

OWNER:

DuWest Realty, LLC
 4403 N. CENTRAL EXWAY SUITE #200
 DALLAS, TX 75025
 CONTACT: BOWEN HENDRIX
 PH: 214.918.1804

APPLICANT:

CLAYMOORE ENGINEERING, INC.
 1903 CENTRAL DRIVE, SUITE #406
 BEDFORD, TX 76021
 CONTACT: DREW DONOSKY
 PH: 817.281.0572

CASE NUMBER

Z2022-003

I HEREBY CERTIFY THAT THE ABOVE AND FOREGOING SITE PLAN FOR A DEVELOPMENT IN THE CITY OF ROCKWALL, TEXAS, WAS APPROVED BY THE PLANNING AND ZONING COMMISSION OF THE CITY OF ROCKWALL ON THE _____ DAY OF _____

WITNESS OUR HANDS THIS _____ DAY OF _____

PLANNING AND ZONING COMMISSION, CHAIRMAN

DIRECTOR OF PLANNING AND ZONING

DUWEST ROCKWALL
SH 205 & QUAIL RUN RD
ROCKWALL, TX

LANDSCAPE PLANTING
PLAN

DESIGN: LRR
 DRAWN: LRR
 CHECKED: CLC
 DATE: 04/05/2022

LP-1

NOTE: THE DEVELOPER SHALL ESTABLISH GRASS AND MAINTAIN THE SODDED AREA, INCLUDING WATERING, UNTIL A PERMANENT STAND OF GRASS IS OBTAINED AT WHICH TIME THE PROJECT WILL BE ACCEPTED BY THE CITY. A STAND OF GRASS SHALL CONSIST OF 75%-80% COVERAGE AND A MINIMUM OF 1" IN HEIGHT AS DETERMINED BY THE CITY.

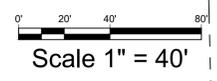



PRELIMINARY FOR REVIEW ONLY Not for construction purposes. CLAYMOORE ENGINEERING ENGINEERING AND PLANNING CONSULTANT DREW DONOSKY Engineer, P.E. No. 125651, Exp. 8/11/2023

DUWEST ROCKWALL SH 205 & QUAIL RUN RD ROCKWALL, TX

LANDSCAPE STANDARDS PLANTING DETAILS & NOTES

DESIGN: LRR DRAWN: LRR CHECKED: CLC DATE: 04/05/2022 SHEET LP-2 File No. 2022-002

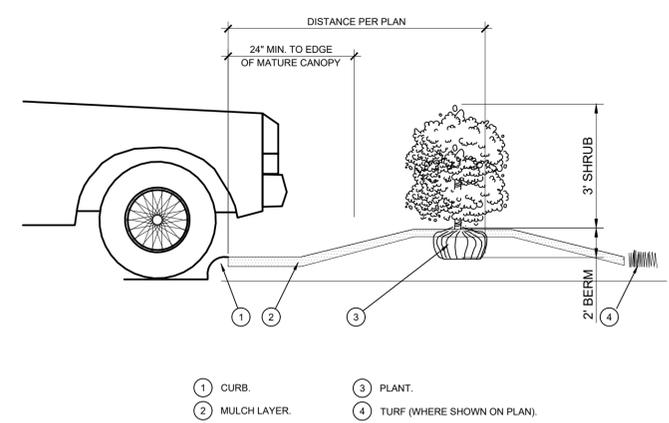

D PLANTING AT PARKING AREA SCALE: NOT TO SCALE

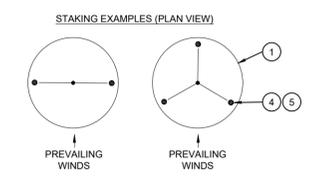
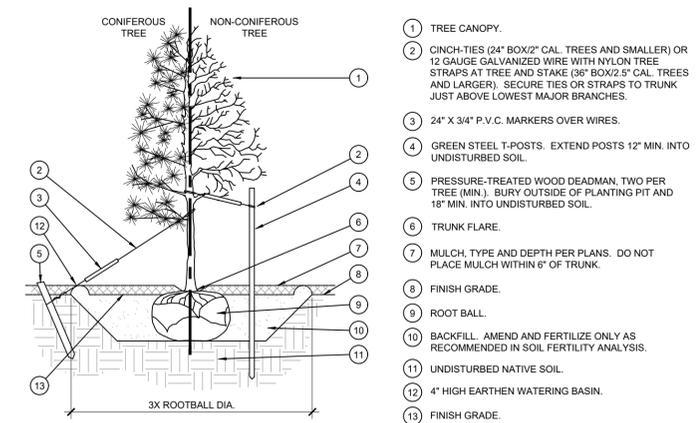

A TREE PLANTING SCALE: NOT TO SCALE

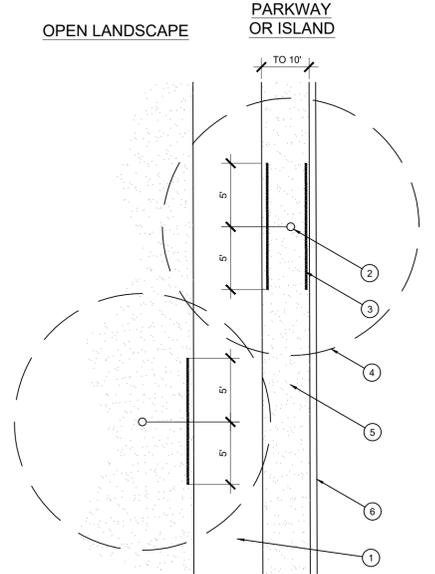

E ROOT BARRIER - PLAN VIEW SCALE: NOT TO SCALE

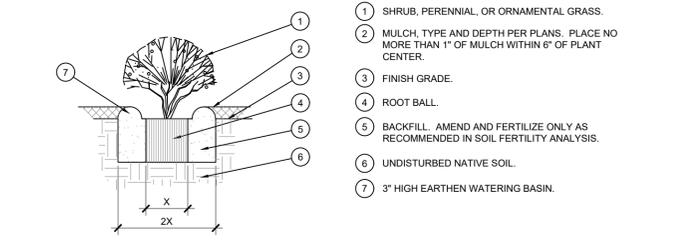

B SHRUB AND PERENNIAL PLANTING SCALE: NTS

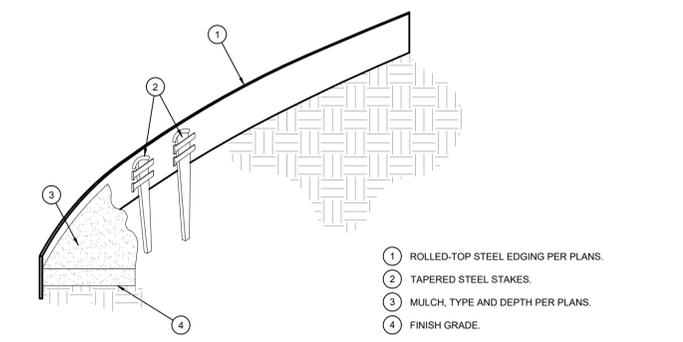

D STEEL EDGING SCALE: NOT TO SCALE

LANDSCAPE STANDARDS	
05.01 LANDSCAPE BUFFERS - NON-RESIDENTIAL	
REQ. ABUTTING A PUBLIC RIGHT-OF-WAY:	10' WIDE LANDSCAPE BUFFER W/ GROUND COVER, BERM, AND SHRUBBERY 30" HIGH + 1 CANOPY TREE & 1 ACCENT TREE PER 50 LIN. FEET OF FRONTAGE
E. QUAIL RUN RD.: ±149' STREET FRONTAGE	10' WIDE BUFFER REQ. W/ 1 CANOPY + 1 ACCENT TREE PER 50 LIN. FT. OF FRONTAGE; GROUND COVER, BUILT-UP BERM AND SHRUBBERY ALONG ENTIRE FRONTAGE
REQUIRED PLANTING: PROVIDED 10' BUFFER:	3 CANOPY TREES, 3 ACCENT TREES, BERM W/ SHRUBS 2 EXIST. CANOPY TREES + 1 NEW CANOPY TREE (CEDAR ELM); 3 ACCENT TREES (REDBUD) W/ BERM AND SHRUBS 3-TIERED BUFFER REQ. 10 REDBUDS
SOUTH PROPERTY LINE BUFFER:	
05.02 LANDSCAPE SCREENING	
REQ. HEADLIGHT SCREENING	HEAD-IN PARKING ADJ. TO STREET SHALL INCORP. MIN. 2' BERM W/ MATURE EVERGREEN SHRUBS ALONG ENTIRE PARKING AREAS
PROVIDED SCREENING	TEXAS SAGE SHRUBS PROVIDED IN FRONT OF PARKING SPACES LOCATED ALONG STREET FRONTAGES
SCREENING FROM RESIDENTIAL	WROUGHT IRON FENCE W/ 3-TIERED SCREEN OF CANOPY TREES & 2 ROWS OF EVERGREEN ACCENT TREES
05.03 LANDSCAPE REQUIREMENTS - COMMERCIAL (C) DISTRICT	
TOTAL SITE AREA:	4311,062 SF
LANDSCAPE AREA REQUIRED TOTAL SITE:	62,212.4 SF (20%)
LANDSCAPE PROVIDED, TOTAL SITE:	± 186,529 SF (60%)
LOCATION OF LANDSCAPING:	MIN. 50% OF REQ. LANDSCAPING SHALL BE LOCATED IN THE FRONT OF & ALONG THE SIDE OF BUILDINGS W/ STREET FRONTAGE.
LANDSCAPE AREAS IN FRONT & SIDES OF BUILDINGS:	61,293 SF (98.5%)
MIN. SIZE OF AREAS	ALL REQ. LANDSCAPING SHALL BE NO LESS THAN 5' WIDE AND A MIN. OF 25 SF IN AREA
DETENTION BASINS	NONE PROPOSED
PARKING LOT LANDSCAPING	MIN. 5% OR 200 SF OF LANDSCAPING, WHICHEVER IS GREATER, IN THE INTERIOR OF PARKING LOT AREA.
PROPOSED PARKING AREA:	±5,011 SF
PROPOSED PARKING LOT LANDSCAPING:	±9,968 SF (9.9%) REQ. PARKING SPACES MUST BE WITHIN 80' OF A CANOPY TREE TRUNK

GENERAL GRADING AND PLANTING NOTES

- BY SUBMITTING A PROPOSAL FOR THE LANDSCAPE PLANTING SCOPE OF WORK, THE CONTRACTOR CONFIRMS THAT HE HAS READ, AND WILL COMPLY WITH, THE ASSOCIATED NOTES, SPECIFICATIONS, AND DETAILS WITH THIS PROJECT.
- THE GENERAL CONTRACTOR IS RESPONSIBLE FOR REMOVING ALL EXISTING VEGETATION (EXCEPT WHERE NOTED TO REMAIN).
- IN THE CONTEXT OF THESE PLANS, NOTES, AND SPECIFICATIONS, "FINISH GRADE" REFERS TO THE FINAL ELEVATION OF THE SOIL SURFACE (NOT TOP OF MULCH) AS INDICATED ON THE GRADING PLANS.
 - BEFORE STARTING WORK, THE LANDSCAPE CONTRACTOR SHALL VERIFY THAT THE ROUGH GRADES OF ALL LANDSCAPE AREAS ARE WITHIN ±0.1' OF FINISH GRADE. SEE SPECIFICATIONS FOR MORE DETAILED INSTRUCTION ON TURF AREA AND PLANTING BED PREPARATION.
 - CONSTRUCT AND MAINTAIN FINISH GRADES AS SHOWN ON GRADING PLANS, AND CONSTRUCT AND MAINTAIN SLOPES AS RECOMMENDED BY THE GEOTECHNICAL REPORT. ALL LANDSCAPE AREAS SHALL HAVE POSITIVE DRAINAGE AWAY FROM STRUCTURES AT THE MINIMUM SLOPE SPECIFIED IN THE REPORT AND ON THE GRADING PLANS, AND AREAS OF POTENTIAL PONDING SHALL BE REGRADED TO BLEND IN WITH THE SURROUNDING GRADES AND ELIMINATE PONDING POTENTIAL.
 - THE LANDSCAPE CONTRACTOR SHALL DETERMINE WHETHER OR NOT THE EXPORT OF ANY SOIL WILL BE NEEDED, TAKING INTO ACCOUNT THE ROUGH GRADE PROVIDED, THE AMOUNT OF SOIL AMENDMENTS TO BE ADDED (BASED ON A SOIL TEST, PER SPECIFICATIONS), AND THE FINISH GRADES TO BE ESTABLISHED.
 - ENSURE THAT THE FINISH GRADE IN SHRUB AREAS IMMEDIATELY ADJACENT TO WALKS AND OTHER WALKING SURFACES, AFTER INSTALLING SOIL AMENDMENTS, IS 3" BELOW THE ADJACENT FINISH SURFACE, IN ORDER TO ALLOW FOR PROPER MULCH DEPTH. TAPER THE SOIL SURFACE TO MEET FINISH GRADE, AS SPECIFIED ON THE GRADING PLANS, AT APPROXIMATELY 18" AWAY FROM THE WALKS.
 - ENSURE THAT THE FINISH GRADE IN TURF AREAS IMMEDIATELY ADJACENT TO WALKS AND OTHER WALKING SURFACES, AFTER INSTALLING SOIL AMENDMENTS, IS 1" BELOW THE FINISH SURFACE OF THE WALKS. TAPER THE SOIL SURFACE TO MEET FINISH GRADE, AS SPECIFIED ON THE GRADING PLANS, AT APPROXIMATELY 18" AWAY FROM THE WALKS.
 - SHOULD ANY CONFLICTS AND/OR DISCREPANCIES ARISE BETWEEN THE GRADING PLANS, GEOTECHNICAL REPORT, THESE NOTES AND PLANS, AND ACTUAL CONDITIONS, THE CONTRACTOR SHALL IMMEDIATELY BRING SUCH ITEMS TO THE ATTENTION OF THE LANDSCAPE ARCHITECT, GENERAL CONTRACTOR, AND OWNER.
- ALL PLANT LOCATIONS ARE DIAGRAMMATIC. ACTUAL LOCATIONS SHALL BE VERIFIED WITH THE LANDSCAPE ARCHITECT OR DESIGNER PRIOR TO PLANTING. THE LANDSCAPE CONTRACTOR SHALL ENSURE THAT ALL REQUIREMENTS OF THE PERMITTING AUTHORITY ARE MET (I.E., MINIMUM PLANT QUANTITIES, PLANTING METHODS, TREE PROTECTION METHODS, ETC.).
 - THE LANDSCAPE CONTRACTOR IS RESPONSIBLE FOR DETERMINING PLANT QUANTITIES; PLANT QUANTITIES SHOWN ON LEGENDS AND CALLOUTS ARE FOR GENERAL INFORMATION ONLY. IN THE EVENT OF A DISCREPANCY BETWEEN THE PLAN AND THE PLANT LEGEND, THE PLANT QUANTITY AS SHOWN ON THE PLAN (FOR INDIVIDUAL SYMBOLS) OR CALLOUT (FOR GROUNDCOVER PATTERNS) SHALL TAKE PRECEDENCE.
 - NO SUBSTITUTIONS OF PLANT MATERIALS SHALL BE ALLOWED WITHOUT THE WRITTEN PERMISSION OF THE LANDSCAPE ARCHITECT. IF SOME OF THE PLANTS ARE NOT AVAILABLE, THE LANDSCAPE CONTRACTOR SHALL NOTIFY THE LANDSCAPE ARCHITECT IN WRITING (VIA PROPER CHANNELS).
 - THE CONTRACTOR SHALL, AT A MINIMUM, PROVIDE REPRESENTATIVE PHOTOS OF ALL PLANTS PROPOSED FOR THE PROJECT. THE CONTRACTOR SHALL ALLOW THE LANDSCAPE ARCHITECT AND THE OWNER/OWNER'S REPRESENTATIVE TO INSPECT, AND APPROVE OR REJECT, ALL PLANTS DELIVERED TO THE JOBSITE. REFER TO SPECIFICATIONS FOR ADDITIONAL REQUIREMENTS FOR SUBMITTALS.
- THE CONTRACTOR SHALL MAINTAIN THE LANDSCAPE IN A HEALTHY CONDITION FOR 90 DAYS AFTER ACCEPTANCE BY THE OWNER. REFER TO SPECIFICATIONS FOR CONDITIONS OF ACCEPTANCE FOR THE START OF THE MAINTENANCE PERIOD, AND FOR FINAL ACCEPTANCE AT THE END OF THE MAINTENANCE PERIOD.
- SEE SPECIFICATIONS AND DETAILS FOR FURTHER REQUIREMENTS.

PLOTTED BY: DARCY BRANDON 8/11/2023 4:19 PM
PLOT DATE: 8/11/2023 4:19 PM
C:\USERS\DARCY\DOCUMENTS\DBLA\PROJECTS\2022\VEDG\DUWEST - ROCKWALL, TX\DUWEST-ROCKWALL_LP_2023-08-10.DWG
LOCATION: 8/11/2023 4:18 PM
LAST SAVED: 8/11/2023 4:18 PM

PLOTTED BY: DARCY BRANDON
 PLOT DATE: 8/11/2023 2:53 PM
 C:\USERS\DARCY\DOCUMENTS\DBLA_PROJECTS\2022\EDG\DUWEST - ROCKWALL, TX\DUWEST-ROCKWALL_TD-2022-08-10.DWG
 LOCATION: 8/11/2023 2:51 PM
 LAST SAVED:

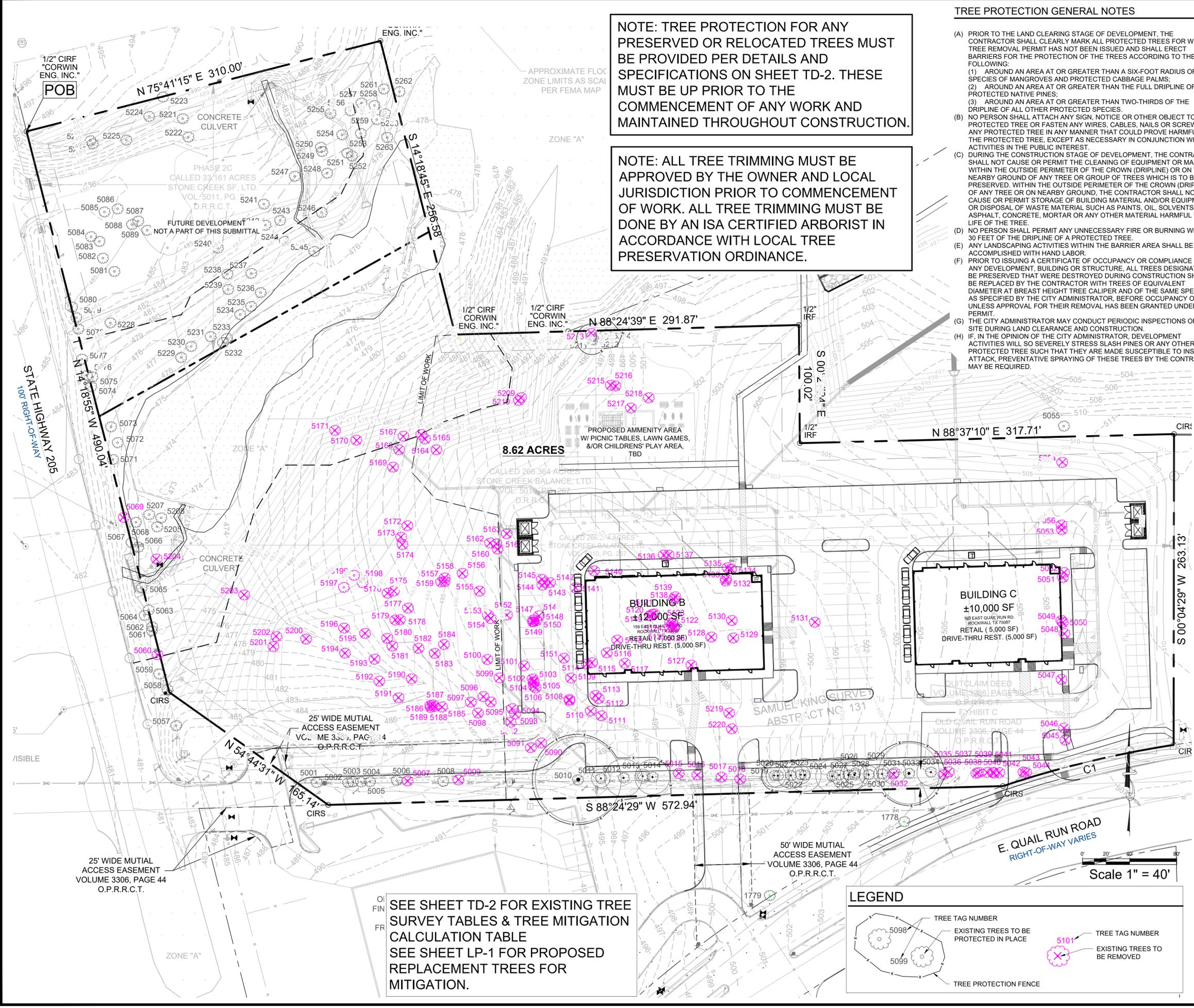

NOTE: TREE PROTECTION FOR ANY PRESERVED OR RELOCATED TREES MUST BE PROVIDED PER DETAILS AND SPECIFICATIONS ON SHEET TD-2. THESE MUST BE UP PRIOR TO THE COMMENCEMENT OF ANY WORK AND MAINTAINED THROUGHOUT CONSTRUCTION.

NOTE: ALL TREE TRIMMING MUST BE APPROVED BY THE OWNER AND LOCAL JURISDICTION PRIOR TO COMMENCEMENT OF WORK. ALL TREE TRIMMING MUST BE DONE BY AN ISA CERTIFIED ARBORIST IN ACCORDANCE WITH LOCAL TREE PRESERVATION ORDINANCE.

TREE PROTECTION GENERAL NOTES

- (A) PRIOR TO THE LAND CLEARING STAGE OF DEVELOPMENT, THE CONTRACTOR SHALL CLEARLY MARK ALL PROTECTED TREES FOR WHICH A TREE REMOVAL PERMIT HAS NOT BEEN ISSUED AND SHALL ERECT BARRIERS FOR THE PROTECTION OF THE TREES ACCORDING TO THE FOLLOWING:
 - (1) AROUND AN AREA AT OR GREATER THAN A SIX-FOOT RADIUS OF ALL SPECIES OF MANGROVES AND PROTECTED CABBAGE PALMS;
 - (2) AROUND AN AREA AT OR GREATER THAN THE FULL DRIPLINE OF ALL PROTECTED NATIVE PINES;
 - (3) AROUND AN AREA AT OR GREATER THAN TWO-THIRDS OF THE DRIPLINE OF ALL OTHER PROTECTED SPECIES.
- (B) NO PERSON SHALL ATTACH ANY SIGN, NOTICE OR OTHER OBJECT TO ANY PROTECTED TREE OR FASTEN ANY WIRES, CABLES, NAILS OR SCREWS TO ANY PROTECTED TREE IN ANY MANNER THAT COULD PROVE HARMFUL TO THE PROTECTED TREE, EXCEPT AS NECESSARY IN CONJUNCTION WITH ACTIVITIES IN THE PUBLIC INTEREST.
- (C) DURING THE CONSTRUCTION STAGE OF DEVELOPMENT, THE CONTRACTOR SHALL NOT CAUSE OR PERMIT THE CLEANING OF EQUIPMENT OR MATERIAL WITHIN THE OUTSIDE PERIMETER OF THE CROWN (DRIPLINE) OR ON THE NEARBY GROUND OF ANY TREE OR GROUP OF TREES WHICH IS TO BE PRESERVED. WITHIN THE OUTSIDE PERIMETER OF THE CROWN (DRIPLINE) OF ANY TREE OR ON NEARBY GROUND, THE CONTRACTOR SHALL NOT CAUSE OR PERMIT STORAGE OF BUILDING MATERIAL AND/OR EQUIPMENT, OR DISPOSAL OF WASTE MATERIAL SUCH AS PAINTS, OIL, SOLVENTS, ASPHALT, CONCRETE, MORTAR OR ANY OTHER MATERIAL HARMFUL TO THE LIFE OF THE TREE.
- (D) NO PERSON SHALL PERMIT ANY UNNECESSARY FIRE OR BURNING WITHIN 30 FEET OF THE DRIPLINE OF A PROTECTED TREE.
- (E) ANY LANDSCAPING ACTIVITIES WITHIN THE BARRIER AREA SHALL BE ACCOMPLISHED WITH HAND LABOR.
- (F) PRIOR TO ISSUING A CERTIFICATE OF OCCUPANCY OR COMPLIANCE FOR ANY DEVELOPMENT, BUILDING OR STRUCTURE, ALL TREES DESIGNATED TO BE PRESERVED THAT WERE DESTROYED DURING CONSTRUCTION SHALL BE REPLACED BY THE CONTRACTOR WITH TREES OF EQUIVALENT DIAMETER AT BREAST HEIGHT TREE CALIPER AND OF THE SAME SPECIES AS SPECIFIED BY THE CITY ADMINISTRATOR, BEFORE OCCUPANCY OR USE, UNLESS APPROVAL FOR THEIR REMOVAL HAS BEEN GRANTED UNDER PERMIT.
- (G) THE CITY ADMINISTRATOR MAY CONDUCT PERIODIC INSPECTIONS OF THE SITE DURING LAND CLEARANCE AND CONSTRUCTION.
- (H) IF, IN THE OPINION OF THE CITY ADMINISTRATOR, DEVELOPMENT ACTIVITIES WILL SO SEVERELY STRESS SLASH PINES OR ANY OTHER PROTECTED TREE SUCH THAT THEY ARE MADE SUSCEPTIBLE TO INSECT ATTACK, PREVENTATIVE SPRAYING OF THESE TREES BY THE CONTRACTOR MAY BE REQUIRED.

SITE DATA TABLE

SITE AREA	8.684 AC / 378,275 SF
ZONING	PD-70 (Planned Development) GR (General Retail Dist.)
PROPOSED USE	RETAIL/DRIVE-THRU RESTAURANT
BUILDING SIZE	BLDG. B - 10,000 SF BLDG. C - 10,000 SF
PATIO AREA	2,777 SF
LOT COVERAGE	5.2%
FLOOR AREA RATIO	0.05:1
BUILDING HEIGHT	1-STORY
IMPERVIOUS AREA	116,406 SF (30.8%)
OPEN SPACE	6.04 AC (69.2%)

PARKING DATA TABLE

PARKING REQUIRED	
RETAIL (10,000 SF) 1 SPACE / 250 SF	40 SPACES
DRIVE-THRU RESTAURANT (10,000 SF) 1 SPACE / 100 SF	100 SPACES
PATIO (2,777 SF) 1 SPACE / 100 SF	28 SPACES
TOTAL PARKING	168 SPACES
ADA PARKING	6 SPACES
PARKING PROVIDED	
TOTAL PARKING	168 SPACES
ADA PARKING	6 SPACES

TREE MITIGATION SUMMARY

TOTAL MITIGATION REQUIRED:	1044.5"
MITIGATION PROVIDED BY PLANTING 4" CALIPER TREES (107) TO BE PLANTED ONSITE:	428"
MITIGATION PROVIDED BY PURCHASING PRESERVATION CREDITS (20% OF TOTAL): (208.9' x \$200 = \$41,780 PAYMENT INTO THE CITY'S TREE FUND)	208.9"
ALTERNATIVE TREE MITIGATION SETTLEMENT REQUEST (407.6' x \$100 / IN = \$40,760):	407.6"
TOTAL MITIGATION PROVIDED:	1044.5"

SEE SHEET TD-2 FOR EXISTING TREE SURVEY TABLES & TREE MITIGATION CALCULATION TABLE
 SEE SHEET LP-1 FOR PROPOSED REPLACEMENT TREES FOR MITIGATION.

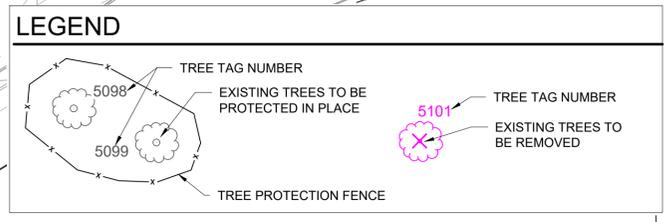

DUWEST ROCKWALL, TX

LEGAL DESCRIPTION AND OR ADDRESS:
**STONE CREEK BALANCE LTD
 ABSTRACT NO 131
 8.684 AC (378,275 SF)**

OWNER:
 DuWEST REALTY, LLC
 4403 N.CENTRAL EXWAY SUITE #200
 DALLAS, TX 75025
 CONTACT: BOWEN HENDRIX
 PH: 214.918.1804

APPLICANT:
 CLAYMOORE ENGINEERING, INC.
 1903 CENTRAL DRIVE, SUITE #406
 BEDFORD, TX 76021
 CONTACT: DREW DONOSKY
 PH: 817.281.0572

CASE NUMBER:
 Z2022-003

I HEREBY CERTIFY THAT THE ABOVE AND FOREGOING SITE PLAN FOR A DEVELOPMENT IN THE CITY OF ROCKWALL, TEXAS, WAS APPROVED BY THE PLANNING AND ZONING COMMISSION OF THE CITY OF ROCKWALL ON THE _____ DAY OF _____.

WITNESS OUR HANDS THIS _____ DAY OF _____.

PLANNING AND ZONING COMMISSION, CHAIRMAN

DIRECTOR OF PLANNING AND ZONING

EVERGREEN DESIGN GROUP
 (800) 680-6630
 15455 Dallas Pkwy., Ste 600
 Addison, TX 75001
 www.EvergreenDesignGroup.com

REGISTERED LANDSCAPE ARCHITECT
 STATE OF TEXAS
 3422
 08/11/2022

PRELIMINARY
 FOR REVIEW ONLY
 Not for construction purposes.
CLAYMOORE ENGINEERING
 ENGINEERING AND PLANNING CONSULTANTS
 DREW DONOSKY
 Engineer, P.E. No. 125651, Date: 8/11/2023

**DUWEST ROCKWALL
 SH 205 & QUAIL RUN RD
 ROCKWALL, TX**

TREESCAPE PLAN

DESIGN: LRR
 DRAWN: LRR
 CHECKED: CLC
 DATE: 04/05/2022
 SHEET
TD-1
 File No. 2022-002
 CASE # SP2022-012
 Page 30 of 168

EXISTING TREE SURVEY

TAG	COMMON NAME	DBH (INCHES)
5001	CEDAR ELM	22
5002	CEDAR ELM	10
5003	CEDAR ELM	10
5004	CEDAR ELM	10
5005	HACKBERRY	24
5006	CEDAR ELM	14
5007	HACKBERRY	12
5008	HACKBERRY	16
5009	HACKBERRY	14
5010	CEDAR ELM	36
5011	HACKBERRY**	8
5012	HACKBERRY	16
5013	CEDAR ELM	6
5014	HACKBERRY	15
5015	BOIS D'ARC**	12
5016	BOIS D'ARC**	10
5017	HACKBERRY	16
5018	HACKBERRY	34
5019	HACKBERRY**	10
5020	HACKBERRY**	10
5021	HACKBERRY	11
5022	HACKBERRY**	8
5023	HACKBERRY	14
5024	HACKBERRY	14
5025	HACKBERRY**	8
5026	HACKBERRY	14
5027	HACKBERRY**	10
5028	BOIS D'ARC**	12
5029	HACKBERRY**	8
5030	HACKBERRY**	7
5031	HACKBERRY**	10
5032	HERCULES CLUB	10
5033	HACKBERRY	26
5034	HACKBERRY	12
5035	HACKBERRY	15
5036	BOIS D'ARC**	14
5037	CEDAR ELM	8
5038	HACKBERRY**	10
5039	BOIS D'ARC**	14
5040	HACKBERRY**	10
5041	HACKBERRY**	10
5042	HACKBERRY**	10
5043	HACKBERRY**	10
5044	HACKBERRY	12
5045	CEDAR ELM	36
5046	CEDAR ELM	36
5047	HACKBERRY	16
5048	HACKBERRY	26
5049	HACKBERRY	12
5050	CEDAR ELM	14
5051	CEDAR ELM	30
5052	HACKBERRY	24
5053	HACKBERRY**	10
5054	HACKBERRY	12
5055	HACKBERRY	38
5056	HACKBERRY	18
5057	CEDAR	24
5058	HACKBERRY	12
5059	HACKBERRY	24
5060	ELM	30
5061	ELM	23
5062	HACKBERRY**	8
5063	ELM	7
5064	ELM	25
5065	HACKBERRY	13
5066	PECAN	50
5067	PECAN	20
5068	WILLOW**	13
5069	ELM	13
5071	ELM	15
5072	PECAN	39
5073	PECAN	23
TOTAL CALIPER INCHES		979.5
CALIPER INCHES NON-PROTECTED		236
TOTAL CALIPER INCHES PROTECTED		608.5
TOTAL CAL. IN. DEAD OR POOR COND.		172
TOTAL CALIPER INCHES REMOVED*		186
TOTAL CALIPER INCHES PRESERVED		422.5
MITIGATION REQUIRED		308*

SHADED ROWS INDICATE TREES TO BE REMOVED
 * DOES NOT INCLUDE NON-PROTECTED TREES, INCLUDES FEATURE TREES, PRIMARY & SECONDARY PROTECTED TREES
 **NON-PROTECTED TREES

TAG	COMMON NAME	DBH (INCHES)
5090	BOIS D'ARC**	30
5091	PECAN	12
5092	ELM	10
5093	ELM	7
5094	HACKBERRY**	8
5095	HACKBERRY**	9
5096	ELM	6
5097	ELM	12
5098	HACKBERRY	11
5099	BOIS D'ARC**	26
5100	CEDAR**	9
5101	WILLOW**	13
5102	HACKBERRY	13
5103	HACKBERRY**	10
5104	HACKBERRY**	6
5105	HACKBERRY	12
5106	HACKBERRY**	9
5107	BOIS D'ARC**	30
5108	HACKBERRY	19
5109	HACKBERRY**	10
5110	ELM	8
5111	ELM	7
5112	HACKBERRY	13
5113	HACKBERRY**	6
5114	HACKBERRY**	9
5115	HERCULES CLUB	6
5116	HACKBERRY**	8
5117	BOIS D'ARC**	36
5118	LOCUST**	12
5119	HACKBERRY	12
5120	BOIS D'ARC**	18
5121	HACKBERRY	14
5122	HACKBERRY**	8
5123	HACKBERRY**	6
5124	BOIS D'ARC**	18
5125	HACKBERRY**	10
5126	HACKBERRY**	10
5127	HACKBERRY**	10
5128	HACKBERRY**	6
5129	HACKBERRY	12
5130	HACKBERRY**	6
5131	HACKBERRY	14
5132	HACKBERRY	12
5133	HACKBERRY**	8
5134	CEDAR	12
5135	CEDAR	12
5136	HACKBERRY	17
5137	BOIS D'ARC**	26
5138	HACKBERRY	14
5139	BOIS D'ARC**	20
5140	CEDAR	14
5141	BOIS D'ARC**	38
5142	HACKBERRY	18
5143	BOIS D'ARC**	14
5144	HACKBERRY	19
5145	BOIS D'ARC**	12
5146	CEDAR**	7
5147	BOIS D'ARC**	10
5148	HACKBERRY**	10
5149	BOIS D'ARC**	10
5150	HACKBERRY**	7
5151	ELM	10
5152	HACKBERRY**	7
5153	CEDAR**	6
5154	BOIS D'ARC**	34
5155	BOIS D'ARC**	36
5156	CEDAR**	10
5157	HACKBERRY	20
5158	BOIS D'ARC**	8
5159	HACKBERRY	13
5160	HACKBERRY	16
5161	HACKBERRY	12
5162	CEDAR**	8
5163	HERCULES CLUB	8
5164	CEDAR**	10
5165	CEDAR**	8
5166	CEDAR**	10
5167	CEDAR	12
5168	BOIS D'ARC**	39
5169	CEDAR**	9
5170	CEDAR**	10
5171	BOIS D'ARC**	40
5172	CEDAR	12
5173	CEDAR**	7
5174	BOIS D'ARC**	31
5175	CEDAR**	8
TOTAL CALIPER INCHES		1,173
CALIPER INCHES NON-PROTECTED		725
TOTAL CALIPER INCHES PROTECTED		416
TOTAL CAL. IN. DEAD OR POOR COND.		0
TOTAL CALIPER INCHES REMOVED*		416
TOTAL CALIPER INCHES PRESERVED		0
MITIGATION REQUIRED		251

SHADED ROWS INDICATE TREES TO BE REMOVED
 * DOES NOT INCLUDE NON-PROTECTED TREES, INCLUDES FEATURE TREES, PRIMARY & SECONDARY PROTECTED TREES
 **NON-PROTECTED TREES

TAG	COMMON NAME	DBH (INCHES)
5176	HACKBERRY**	8
5177	CEDAR**	6
5178	BOIS D'ARC**	21
5179	HACKBERRY**	8
5180	HACKBERRY**	8
5181	CEDAR**	10
5182	BOIS D'ARC**	14
5183	CEDAR**	6
5184	BOIS D'ARC**	26
5185	HACKBERRY**	10
5186	BOIS D'ARC**	10
5187	HACKBERRY**	9
5188	BOIS D'ARC**	10
5189	BOIS D'ARC**	14
5190	HACKBERRY	16
5191	ELM	10
5192	ELM	8
5193	ELM	6
5194	BOIS D'ARC**	20
5195	BOIS D'ARC**	11
5196	HERCULES CLUB	13
5197	BOIS D'ARC**	33
5198	HACKBERRY**	8
5199	HACKBERRY**	6
5200	ELM	28
5201	CEDAR	12
5202	CEDAR**	10
5203	ELM	25
5204	WILLOW**	30
5205	WILLOW**	13
5207	WILLOW**	12
5208	WILLOW**	16
5209	BOIS D'ARC**	25
5210	HACKBERRY	20
5211	HERCULES CLUB	10
5212	HACKBERRY**	10
5213	BOIS D'ARC**	28
5214	HACKBERRY**	10
5215	HACKBERRY**	10
5216	HACKBERRY**	10
5217	HERCULES CLUB	8
5218	HERCULES CLUB	8
5219	HACKBERRY	12
5220	HACKBERRY	14

TOTAL CALIPER INCHES	1,599
CALIPER INCHES NON-PROTECTED	623
TOTAL CALIPER INCHES PROTECTED	1,165
TOTAL CAL. IN. DEAD OR POOR COND.	68
TOTAL CALIPER INCHES REMOVED*	716
TOTAL CALIPER INCHES PRESERVED	449
MITIGATION REQUIRED	1,058*

SHADED ROWS INDICATE TREES TO BE REMOVED
 * DOES NOT INCLUDE NON-PROTECTED TREES, INCLUDES FEATURE TREES, PRIMARY & SECONDARY PROTECTED TREES
 **NON-PROTECTED TREES

DESCRIPTION	CALIPER INCHES	FEATURE TREES	FEATURE TREES REMOVED 2:1	PRIMARY PROTECTED TREES	PRIMARY PROTECTED REMOVED 1:1	SECONDARY PROTECTED TREES	SECONDARY PROTECTED REMOVED 0.5:1	NON-PROTECTED TREES
TOTAL TREES ON SITE (NOT INC. DEAD OR POOR CONDITION TREES)	3,511.5	787		777		625.5		1,584
TOTAL PROTECTED TREES	2,189.5							
TREES REMOVED	1,318.0		521		353		444	
TOTAL MITIGATION REQUIRED	1,617.0		1,042		353		222	
20% INTO TREE FUND (\$200 / INCH)	323.4							
4" TREES PLANTED FOR MITIGATION (107)	428.0							
BALANCE OF MITIGATION	1189.0							

DUWEST ROCKWALL, TX

LEGAL DESCRIPTION AND OR ADDRESS:
STONE CREEK BALANCE LTD
 ABSTRACT. NO 131
 8.684 AC (378,275 SF)

OWNER:
 DuWEST REALTY, LLC
 4403 N.CENTRAL EXWAY SUITE #200
 DALLAS, TX 75025
 CONTACT: BOWEN HENDRIX
 PH: 214.918.1804

APPLICANT:
 CLAYMOORE ENGINEERING, INC.
 1903 CENTRAL DRIVE, SUITE #406
 BEDFORD, TX 76021
 CONTACT: DREW DONOSKY
 PH: 817.281.0572

CASE NUMBER
 Z2022-003

I HEREBY CERTIFY THAT THE ABOVE AND FOREGOING SITE PLAN FOR A DEVELOPMENT IN THE CITY OF ROCKWALL, TEXAS, WAS APPROVED BY THE PLANNING AND ZONING COMMISSION OF THE CITY OF ROCKWALL ON THE _____ DAY OF _____.

WITNESS OUR HANDS THIS _____ DAY OF _____.

PLANNING AND ZONING COMMISSION, CHAIRMAN

 DIRECTOR OF PLANNING AND ZONING

TREESCAPE PLAN

EXISTING TREE INVENTORY

DESIGN: LRR
 DRAWN: LRR
 CHECKED: CLC
 DATE: 04/05/2022

SHEET
TD-2

File No. 2022-012
 Page 91 of 168



TEXAS REGISTRATION #14199
CLAY MOORE
ENGINEERING
 PHONE: 817.281.0572
 1903 CENTRAL DR. SUITE 406
 BEDFORD, TX 76021
 WWW.CLAYMOOREENG.COM

PRELIMINARY
 FOR REVIEW ONLY
 Not for construction purposes.
CLAYMOORE ENGINEERING
 ENGINEERING AND PLANNING CONSULTANTS
 DREW DONOSKY
 Engineer, P.E. No. 125651, State 8/11/2023

DUWEST ROCKWALL
SH 205 & QUAIL RUN RD
ROCKWALL, TX

PLOTTED BY: DARCY BRANDON
 PLOT DATE: 8/11/2023 2:56 PM
 LOCATION: C:\USERS\DARCY\DOCUMENTS\DBLA_PROJECTS\2022\EDG\DUWEST - ROCKWALL, TX\DUWEST-ROCKWALL_Td-2022-08-10.DWG
 LAST SAVED: 8/11/2023 2:56 PM



City of Rockwall
The New Horizon

MEMORANDUM

TO: Rockwall City Council

FROM: Joey Boyd, Assistant City Manager

DATE: September 22, 2023

SUBJECT: STAR Transit Contract for Fiscal Year 2024

Included for City Council review and consideration is the agreement between the City of Rockwall and STAR Transit for transportation services in the City for fiscal year 2024.

The key points of the agreement are:

- The term of the agreement is: October 1, 2023 through September 30, 2024.
- The City and STAR agree that no fixed route service may be provided under the terms of this Agreement, that no funds from this Agreement will be utilized to support a fixed route service, and that STAR Transit will not request funds or in kind support from the City if STAR Transit elects to operate a fixed route in the City of Rockwall under funding outside of this Agreement.
- Service will be provided five (5) days per week, Monday through Friday, calculated as 250 service days for the fiscal year. A total of 22 hours of in-service time including pre- and post-trip time on average each operating day will be limited exclusively to trip origins in the incorporated areas of the City of Rockwall.
- The hourly rate charged for transit service is \$55.00.

The City Council is asked to consider approval of the contract with STAR Transit in the amount of \$121,000 and authorize the City Manager to execute the agreement on behalf of the City of Rockwall. Funds are available in the Administration Operating Budget for this service.

**INTERLOCAL COOPERATIVE AGREEMENT
BETWEEN
STAR TRANSIT
AND
CITY OF ROCKWALL, TEXAS**

This Interlocal Cooperative Agreement ("Agreement") is between STAR TRANSIT ("STAR Transit") and the CITY OF ROCKWALL, Texas ("CITY"), a political subdivision of the state of Texas and each organized and existing under the laws of the State of Texas, and acting by, through and under the authority of their respective governing bodies. STAR Transit and the CITY may each be referred to as a "Party" to this Agreement and may be collectively referred to as "Parties" in this Agreement.

WITNESSETH

WHEREAS, STAR Transit is a Rural Transit District established pursuant to the authority of Chapter 458, Texas Transportation Code, as amended, with its headquarters in Terrell, Texas, and currently provides transit services within several area jurisdictions; and

WHEREAS, the CITY is a local government entity of the State of Texas; and located in Rockwall County; and

WHEREAS, the CITY has requested STAR Transit provide services and is authorized to execute this Agreement with STAR Transit for the purpose of providing for the operation and management of public transportation services for the benefit of the citizens of the CITY; and

WHEREAS, STAR Transit, its officers and supervisory employees are trained and experienced in the operation and management of public transportation and is authorized to execute this Agreement with the CITY for the purpose of providing services as specified herein; and

WHEREAS, the Agreement is made pursuant to and under the authority of the Interlocal Cooperation Act of 1971, as amended, and codified in Chapter 791 of the Texas Government Code (the "Act"); and

WHEREAS, STAR Transit and the CITY are local governments as defined in §791.003 of the Act, and each are empowered by §791.011 of the Act to contract with each other to provide governmental functions and services including public and elderly transportation; and

WHEREAS, STAR Transit publishes an annual cost of service letter with its Fiscal Year operating cost schedule no later than June 1 each year and utilizes an hourly rate to adjust amounts payable by its local partners, including CITY, each year; and,

WHEREAS, the purpose of this Agreement is to provide a variety of public transit services to the benefit of residents and businesses in the CITY, the "Public Transit Services".

NOW, THEREFORE, for and in consideration of the mutual promises and covenants contained herein, the receipt and sufficiency of which are hereby acknowledged, the Parties hereby agree as follows:

ARTICLE I

Incorporation of Recitals

The foregoing recitals are hereby incorporated into the body of this Agreement and shall be considered part of the mutual covenants, consideration and promises that bind the Parties.

ARTICLE II

Term

This Agreement shall be effective upon execution by both Parties with services already in progress due to previous arrangements between the Parties and the initial term shall begin on October 1, 2023 and end on September 30, 2024. If not otherwise terminated in accordance with the termination provisions of Article V of this Agreement, this Agreement extends for subsequent twelve (12) month periods starting on the first (1st) day of October each year. STAR Transit shall notify the City by August 1st during the term of the contract or any extension, to determine if the contract terms need to be renegotiated or if the contract can be extended by terms of this section.

ARTICLE III

Rights, Duties and Responsibilities of STAR Transit

- 3.1 Board of Directors. STAR Transit is designated to supervise the performance of this Agreement and to operate the Public Transit Service within the CITY's jurisdictions and subdivisions. Such operations shall be overseen solely by the STAR Transit Board of Directors. STAR Transit shall be responsible for the safe, efficient, and effective operation of all services provided.
- 3.2 Management Scope. STAR Transit agrees to manage, supervise and operate the Public Transit Services in an efficient and economical manner. STAR Transit shall operate all properties, equipment, facilities, routes, and services now or hereafter existing for the purposes of this Agreement. STAR Transit shall provide full and complete management services for the Public Transit Service and any specific duties and obligations set forth shall not be construed as limitations. STAR Transit shall perform the active direction of the Public Transit Services, including transportation, maintenance, schedule preparation, dispatching, communications, accounting, public relations, and safety. All such services may be provided at the principal office of STAR Transit in Terrell, Texas or at such other place, or places as STAR Transit shall determine.
- 3.3 Administrative Functions. STAR Transit shall administer all properties, equipment, buses, vehicles, facilities, maintenance, gasoline, repairs, replacements, services, expenditures, and resources necessary for safe, efficient, and effective operations. STAR Transit shall employ, train, furnish, and supervise the personnel necessary for the operation of the Public Transit Services. STAR Transit shall oversee all aspects of employment including employee recruiting, selection, training, wages and benefits. STAR Transit shall perform all aspects of general administrative oversight including technical guidance, payroll, accounts payable, purchasing, contracting, finance and other administration necessary for the proper operation of the system.
- 3.4 Transit Vehicle Operators. Every vehicle providing Public Transit Service under this Agreement shall be operated by an operator duly licensed by the State of Texas to operate vehicles of the type

and size being operated by such operator and such operator shall be appropriately dress in a uniform selected by STAR Transit.

3.5 Routes, Schedules, Fares. The Public Transit Services shall be operated with routes and schedule established by STAR Transit with input from CITY. In no case shall the Public Transit Services operate on a Saturday, Sunday, regular annual holidays as designated by the STAR Transit Board of Directors, or days on which STAR Transit deem conditions are unsafe or otherwise inappropriate for service in accordance with Section 7.4. STAR Transit shall have authority to make modifications to any routes without the necessity of obtaining CITY approval. In no case shall the Public Transit Services require a service beginning prior to 5:00 AM or ending after 9:00 PM. Fares for riders shall be established by the STAR Transit Board of Directors and such fares shall be consistent throughout the STAR Transit system. The Parties agree that no fixed route service may be provided under the terms of this Agreement, that no funds from this Agreement will be utilized to support a fixed route service, and that STAR Transit will not request funds or in kind support from CITY if STAR Transit elects to operate a fixed route in the City of Rockwall under funding outside of this Agreement.

3.6 Transit Vehicles. STAR Transit shall use only such vehicles as are appropriate to provide the Public Transit Service. All vehicles shall be fully compliant with the Americans with Disabilities Act of 1990, U.S. Code §12101, et. seq., as amended and relevant regulations applicable thereto, licensed for passenger operations by the State of Texas and equipped with a two-way communication system. STAR Transit shall provide or cause to be provided all mechanical and other repairs, maintenance and upkeep necessary to maintain vehicles in good working order and in a clean, sanitary and safe condition.

3.7 Operating Cost Charge to CITY. STAR Transit shall charge for services and CITY agrees to compensate STAR Transit for services based on the following:

A. Service Days: Service up to five (5) days per week, Monday through Friday; set and calculated as two hundred fifty (250) service days each Fiscal Year. This number of Service Days shall be charged each Fiscal Year regardless of actual calendar service days or events as noted in Section 7.4. This number of charged Service Days may be adjusted only by Amendment to the Contract duly approved by CITY and the STAR Transit Board of Directors.

- B. Daily Hours: A total of twenty-two (22) hours of in-service time including pre- and post-trip time on average each operating day. Average Daily Hours may be adjusted, in writing, by mutual agreement of the parties, no more often than once per every one hundred and twenty (120) calendar days.
- C. Hourly Cost: For the first STAR Transit Fiscal Year, average cost per hour shall be charged at forty-nine dollars and fifty cents (\$55.00). Each Fiscal Year thereafter, during the term of this Agreement, the average cost per hour shall be charged at the current STAR Transit Public Transit Hourly Rate. The STAR Transit Board of Directors shall publish an annual cost of service letter with its upcoming Fiscal Year operating cost schedule no later than the first (1st) day of June each year and utilize that hourly rate to adjust amounts payable by CITY.
- D. Annual Operating Cost. Each Fiscal Year, the annual operating cost shall be calculated by multiplying Service Days (Line A) by Daily Hours (Line B) and by Hourly Cost (Line C).
- E. Operating Off-Sets. STAR Transit expects a net sixty percent (60%) operating cost subsidy on the Public Transit Service from a combination of Federal, State, Regional, and Private Contract sources. So long as such subsidy is in place, it shall be used as an off-set to reduce the Annual Operating Cost charged to CITY. The Operating Off-Set may be adjusted only by Amendment to the Agreement duly approved by CITY and the STAR Transit Board of Directors.
- F. Monthly Charge to CITY. The Monthly Charge to CITY shall be the Annual Operating Cost (Line E) multiplied by any Operating Off-Set (Line F) divided by twelve (12). For the first Fiscal Year, the Monthly Charge to CITY is set at ten thousand and eighty-three dollars and thirty-three cents (\$10,083.33). Payment for all services shall be due fifteen (15) days in advance of service. STAR Transit shall invoice CITY for each service month no earlier than fifteen (15) days prior to each service month. For future Fiscal Years, starting with the cost for operations to be performed in October 2023, STAR Transit shall invoice, and CITY agrees to pay, based on the up-to-date monthly calculation as described herein.
- G. Subsequent Fiscal Years. In following STAR Transit Fiscal Years, the monthly charge to CITY shall be calculated by STAR Transit with the identical methodology utilizing any updated parameters. This calculation and the resulting monthly rate will be provided by STAR Transit in writing to CITY prior to the first (1st) day of June each year.
- H. Additional Services. Any month in which the CITY requests average daily hours for non-holiday weekdays exceeding the average daily hours established in Section 3.7 (B) shall be a month in which STAR Transit shall increase the monthly charge in the next available billing cycle by the total number of increased hours (or partial hours) of service multiplied by the current charter rate as established by the STAR Transit Board of Directors. Any other special

services requested by CITY and scheduled by STAR Transit, which is not covered under the specific monthly service terms of this Agreement, or under subsequent duly approved Amendments or modifications, shall be billed to CITY on the next available invoice by STAR Transit at the current charter rate as established by the STAR Transit Board of Directors.

- 3.8 Capital Cost Charge to CITY. The parties concur that the CITY will not participate in capital expenditures.
- 3.9 Marketing. STAR Transit will provide the CITY with service information for posting on the CITY Website and advertise the services on the STAR Transit homepage. As part of its regular outreach programs, STAR Transit will market the Public Transit Service in a variety of media and locations likely to attract potential riders. STAR Transit shall maintain rights to final approval of all marketing materials.
- 3.10 Reporting. STAR Transit will provide the CITY a monthly summary of ridership data within thirty (30) days after the last day of the preceding month, an annual summary of ridership after the end of the STAR Transit Fiscal Year, a copy of the adopted Annual Budget, and a copy of the approved annual audit.
- 3.11 Contract Management. STAR Transit will pursue and apply for grant funding opportunities which may be applicable to and beneficial to the Agreement. STAR Transit will be responsible for complying with the obligations and responsibilities under all grants and all accompanying certifications, assurances, and agreements made or given by the Federal Transit Administration, Texas Department of Transportation, or any other applicable entity. STAR Transit will be responsible for complying with all applicable laws, rules, regulations and guidelines associated with STAR Transit services. STAR Transit will provide any documents needed to support Federal, State, or Regional grant administration or other data or audit requirements to the appropriate entity in a timely manner. Grant funding shall be used to offset monthly charges to the CITY if applicable to service provided within the CITY.
- 3.12 Permits. STAR Transit shall secure or cause to be secured, at its cost and expense, all permits and other governmental authorizations, which may be required to fulfill this Agreement.

ARTICLE IV

Rights, Duties and Responsibilities of the CITY

- 4.1 Payment for Service. CITY shall pay all invoices provided by STAR Transit under this Agreement within thirty (30) days of receipt. Such payments shall constitute a current expense of the CITY and shall not in any way be considered or construed to be a debt of the CITY's in contravention of any constitutional, statutory, or charter provision. Any CITY paying for STAR Transit's services must make those payments with current revenues available and the CITY hereby affirms that funds to pay said payments to STAR Transit are available for the current Fiscal Year.
- 4.2 Parking. Permit STAR Transit to access, park, and store vehicles, as necessary, at a CITY or municipal facility in the CITY.
- 4.3 Promotions. The CITY shall promote services via CITY facilities, municipal resident water bill, CITY Social Media Outlets, News Releases, CITY Website and additional promotional opportunities that become available during the duration of the Agreement. The CITY shall facilitate, as needed and within CITY budget constraints, the efforts of STAR Transit to market the Public Transit Services. CITY shall make all CITY generated marketing materials available for review and approval by STAR Transit.

ARTICLE V

Termination

- 5.1 Program Conclusion. During the initial term, but no later than June 30, 2024, either party may provide written notice of termination to be effective on September 30, 2024. During subsequent twelve (12) month terms, either party may provide written notice of termination no later than June 30 for the following Fiscal Year commencing on the first (1st) day of October.

- 5.2 Mutual Agreement. This Agreement may be terminated immediately at any time by a written agreement signed by both Parties setting forth the agreed termination date.
- 5.3 Termination due to Default. Termination due to Default must be preceded by (1) written notice stating specific provision violated in this Agreement, (2) a thirty (30) day period for cure and (3) a second notice of failure to cure and final termination. A Party shall be in default of this Agreement if such Party fails to timely keep or perform any term, provision, covenant, or condition to be kept or performed by such Party under the terms of this Agreement and/or any other agreement now or hereafter existing between the Parties and such failure continues for thirty (30) days after written notice by the non-defaulting Party to the defaulting Party (a "Default"). Upon the occurrence of a Default, the non-defaulting Party shall have the right to terminate this Agreement by written notice to the defaulting Party and shall further have the right to exercise any and/or all other rights and/or remedies available to such Party at common law, by statute, in equity or otherwise pursuant to the laws of the State of Texas. In addition, CITY may terminate due to default if performance standards are not met or if CITY deems the operation of the service by STAR Transit is unreliable, unsafe or of poor quality.
- 5.4 Termination by Operation or Breach of Law. In the performance of this agreement, STAR Transit shall comply with all state, federal and local laws, regulations and standards. If the purpose or intent of this agreement is prevented or is contrary to any other law, including but not limited to section 458.012, Texas Transportation Code, this agreement shall be deemed null and void and of no force and effect. If the operation of the service by STAR Transit is in violation of any law or regulation that does not frustrate the purpose or intent of this agreement, or if repeated violations occur, the CITY may terminate the service immediately upon notice. Any pre-paid amounts for monthly service shall be immediately refunded to CITY.

ARTICLE VI

Responsible Party Provisions

- 6.1 Legal Liability. As a designated political subdivision, STAR Transit is a "governmental unit" as that term is defined in Chapter 101 of the Texas Civil Practice and Remedies Code. Therefore, the extent of STAR Transit's liability for actions arising out of the operation of a public transportation system shall be governed by Chapter 101 of the Texas Civil Practice and Remedies Code.

- 6.2 Limitation of Liability. To the extent authorized by the Constitution and laws of the State of Texas, the Parties agree that each Party shall be responsible for its own acts and omissions and the acts and omissions of its agents, representatives and employees in the performance of this Agreement. It is expressly understood and agreed by the Parties that neither Party shall be held liable for the acts or omissions of the other Party or for the acts or omissions of the other Party's agents, representatives, or employees in the performance of this Agreement. Both parties shall hold harmless, indemnify and defend the other from and against any claims, damages, losses or liability of any character, type, or description, including all expenses of litigation, court costs, and attorney's fees, for injury or death to any person, injury or loss to any property, or economic loss, received or sustained by any person or persons, or property, directly or indirectly arising out of, or occasioned by the acts, omissions or conduct of the indemnifying party, without waiving the party's governmental, sovereign or other immunities or defenses available under Texas law and without waiving any defenses of the parties under Texas law.
- 6.3 Insurance. Each party shall maintain its own insurance in sufficient amounts to cover any occurrence or claim related to its responsibilities in delivering the Public Transit Services.
- 6.4 Immunity. In the execution and performance of this Agreement, the Parties do not waive, and neither Party shall be deemed to have waived, any immunity or defense that would otherwise be available to each Party as a local governmental entity and/or political subdivision of the State of Texas. Nothing in this Agreement shall be deemed or construed to created any right or interest in any person not a party to this Agreement, and there are no third-party beneficiaries hereof.
- 6.5 Survival. All provisions of this Article shall expressly survive the termination of this Agreement.

Article VII
Miscellaneous

- 7.1 Captions. The descriptive captions of this Agreement are for convenience of reference only and shall in no way define, describe, limit, expand or affect the scope, terms, conditions, or intent of this Agreement.

- 7.2 Compliance with Laws. STAR Transit and its officers, agents and employees shall comply with all applicable federal, state and local health, safety, disability, environmental and other laws, ordinances, rules and regulations in the performance of the Public Transit Service.
- 7.3 Powers. STAR Transit has all the powers of CITY necessary to operate its services. By way of illustration, but not for limitation, STAR Transit has the power to contract, to acquire and own real and personal property, and to accept and expend funds from government, legal entities and individuals. STAR Transit does not have the power to tax, to obligate CITY, to assess CITY, or to adopt ordinances or laws.
- 7.4 Force Majeure. STAR Transit shall not be liable to CITY for any failure, delay, interruption of service caused by acts of God, fire, snow, ice, flooding, tornado, utility outages, riots, civil commotion, labor disruptions, sabotage, sovereign conduct, acts of terror, pandemic, or any other cause beyond the reasonable control of STAR Transit and not attributable to any neglect or negligence on the part of STAR Transit. In the event of such occurrence, the time for performance of such services shall be suspended until such time that such inability to perform shall be removed. STAR Transit shall make all reasonable efforts to mitigate the effects of any such suspension or interruption of service and CITY shall not be entitled to any compensation for any such event.
- 7.5 Severability. The sections, paragraphs, sentences, clauses, and phrases of this Agreement are severable and, if any phrase, clause, sentence, paragraph, or section of this Agreement should be declared invalid, illegal, or unenforceable by the final judgment or decree of any court of competent jurisdiction, such invalidity shall not affect the validity or enforceability of any of the remaining phrases, clauses, sentences, paragraphs, and sections of this Agreement and such remaining provisions shall remain in full force and effect and shall be construed and enforced as if the invalid provision had never been included in the Agreement.
- 7.6 Notices. Any notice required or permitted to be given under the terms of this Agreement shall be in writing and shall be considered properly given if mailed by United States mail, certified mail, return receipt requested, in a postage paid envelope addressed to the Party at the address set forth below, or by delivering same in person to the intended addressee by hand delivery or by a nationally recognized courier service such as Federal Express or United Parcel Service. Notices mailed by certified mail as set forth above shall be effective upon deposit in the United States mail. Notice given in any other manner shall be effective only if and when received by the addressee. For

purposes of notice, the addresses of the Parties shall be as set forth below; provided, however, that any Party shall have the right to change such Party's address for notice purposes by giving the other Party at least thirty (30) days prior written notice of such change of address in the manner set forth herein:

STAR Transit: STAR Transit;
Attn: Executive Director
P.O. Box 703
Terrell, TX 75160

CITY: City of Rockwall
Attn: City Manager
385 S. Goliad Street
Rockwall, TX 75087

- 7.7 Entire Agreement. This Agreement, together with all attachments hereto, sets forth the entire Agreement between the Parties with respect to the subject matter hereof, and all prior discussions, representations, proposals, offers, and oral or written communications of any nature are entirely superseded hereby and extinguished by the execution of this Agreement.
- 7.8 Modification. This Agreement may only be revised, modified, or amended by a written document signed by STAR Transit and the CITY. Oral revisions, modification, or amendments are not permitted.
- 7.9 Waiver. All waivers, to be effective, must be in writing and signed by the waiving party. No failure by either Party to insist upon the strict or timely performance of any covenant, duty, agreement, term, or condition of this Agreement shall constitute a waiver of any such covenant, duty, agreement, term, or condition. No delay or omission in the exercise of any right or remedy accruing to either Party upon a breach of this Agreement shall impair such right or remedy or be construed as a waiver of any such breach or a waiver of any breach theretofore or thereafter occurring.

- 7.10 Authority. Each Party represents and warrants to the other that this Agreement has been authorized by the governing body of such Party and that each such Party has the full power and authority to enter into and fulfill its obligations under this Agreement. Each person signing this Agreement represents that such person has the authority to sign this Agreement on behalf of the Party indicated.

- 7.11 Assignment. This Agreement shall not be assigned or transferred by either Party without prior written consent of the other Party, which consent shall not be unreasonably withheld.

- 7.12 Independence. The Parties are acting herein as independent contractors and independent employers. Nothing herein shall create or be construed as creating a partnership, joint venture or agency relationship between any of the Parties and no Party shall have the authority to bind the other in any respect. Nothing in this Agreement prevents STAR Transit from pursue contracting opportunities to provide any services with other public and private entities within the CITY or outside the CITY.

- 7.13 Effective Date. This Agreement shall not be effective unless and until it is executed by both STAR Transit and the CITY. "Effective Date" as used herein shall mean the later of the two dates this Agreement is executed by STAR Transit and the CITY.

IN WITNESS WHEREOF, the Parties hereto have executed this Agreement by their duly authorized agents, officers, and/or officials on the dates set forth below.

CITY OF ROCKWALL, TX

STAR TRANSIT

By: _____

By: _____

Name: _____

Name: _____

Title: _____

Title: _____

Date: _____

Date: _____



City of Rockwall
The New Horizon

MEMORANDUM

TO: Rockwall City Council

FROM: Joey Boyd, Assistant City Manager

DATE: September 22, 2023

SUBJECT: Contract with Meals On Wheels Senior Services

Margie VerHagen, Executive Director of Meals On Wheels Senior Services, requested funding for nutritional / senior service programs provided in Rockwall in the amount of \$50,000. This amount was approved in the operating budget for this fiscal year. Attached for the City Council's review and consideration is a contract with Meals On Wheels for FY 2024.

The City Council is asked to consider approval of the proposed contract and authorize the City Manager to enter into an agreement with Meals On Wheels Senior Services for nutritional and senior service programs in the City of Rockwall.

**AGREEMENT FOR NUTRITIONAL PROGRAMS
FOR THE ELDERLY AND DISABLED**

STATE OF TEXAS §
COUNTY OF ROCKWALL § **KNOW ALL MEN BY THESE PRESENTS:**

THIS AGREEMENT is entered into by the **CITY OF ROCKWALL, COUNTY OF ROCKWALL, TEXAS** (hereinafter referred to as “**City**”), a municipal corporation, acting by and through Mary Smith, City Manager, its duly authorized representative and **MEALS ON WHEELS SENIOR SERVICES, a nonprofit Texas corporation**, acting by and through Margie VerHagen, its duly authorized representative. The parties do hereby covenant and agree as follows:

Section 1. Grant. For and in consideration of compliance by Meals On Wheels Senior Services with covenants and conditions herein set forth, and the ordinances and regulations of the City, the City hereby contracts with Meals On Wheels Senior Services to provide certain nutritional programs to the elderly and disabled within the corporate limits of the City.

Meals On Wheels Senior Services shall conduct operations in accordance with all federal, state and local laws that exist at the time of the execution of this agreement and any additional laws, regulations, or requirements that may become effective during the term of this agreement. In addition, Meals On Wheels Senior Services agrees to conduct operations in accordance with the description of services outlined in Attachment “A” attached hereto and made a part hereof for all purposes. Meals On Wheels Senior Services shall be responsible for obtaining any permits or licenses required to fulfill its obligations under this agreement.

Section 2. Payment. City agrees to pay Meals On Wheels Senior Services the sum of **Fifty Thousand Dollars and No/Cents (\$50,000.00)** for the provision of certain nutritional / service programs to the elderly and disabled. Said payments shall be made on the following dates: **December 31, 2023 for 1st Quarter, March 31, 2024 for 2nd Quarter, June 30, 2024 for 3rd Quarter, and September 30, 2024 for 4th Quarter upon Receiving a Quarterly Report and Invoice.**

Section 3. Term. This agreement is to take effect and continue and remain in full force and effect for a period to expire on September 30, 2024.

Section 4. Scope and Nature of Operation. It is expressly agreed and understood that Meals On Wheels Senior Services shall provide the services as outlined in Attachment “A” continuously during the contract period.

Section 5. Surety and Cancellation. If at any time, the City Council determines that Meals On Wheels Senior Services has failed to perform, or performed in an unacceptable manner, any of the terms, covenants or conditions herein set forth, the City may revoke and cancel this agreement. The City Council shall be the sole judge of whether Meals On Wheels Senior Services has failed to perform. Meals On Wheels Senior Services shall be given written notice at least 10 days prior to consideration by the City Council of such action. Should the City Council revoke this agreement, Meals On Wheels Senior Services shall be responsible for reimbursing the City on a pro-rata basis any unearned funds paid by the City.

Section 6. Complaint Handling by Meals On Wheels Senior Services. Meals On Wheels Senior Services shall, at its own expense, provide a locally accessible telephone number and will answer calls from 9:00 a.m. until 5:00 p.m. daily, Monday through Friday, excluding such holidays as may be approved by the City, for the purpose of handling complaints and other calls regarding services provided by Meals On Wheels Senior Services. Meals On Wheels Senior Services shall maintain a log of all complaints and disposition of the complaints. This log shall be submitted to the City on a monthly basis. All complaints shall be given prompt and courteous attention and when possible, shall be resolved within a 24-hour period.

Section 7. Vehicular Identification. There are no vehicle identification requirements at this time. Provided that such markings or identification becomes necessary during the term of this agreement, the parties agree to implement such markings, and if so, will be the responsibility of Meals On Wheels Senior Services.

Section 8. Reporting. Meals On Wheels Senior Services shall provide quarterly reports to the City detailing the following:

Nutritional Programs for the Elderly and Disabled

- a. Number of users – average daily and monthly totals
- b. Type of services provided
- c. Complaint logs

Section 9. Books and Records. Meals On Wheels Senior Services agrees to maintain adequate books and records relating to their performance under the provisions of the Agreement. The City may request from Meals On Wheels Senior Services specific periodic reports containing information deemed necessary by the City. The records of Meals On Wheels Senior Services applicable to the performance of this agreement shall and will be available when wanted for inspection by the City at any time during normal working hours upon 10 days written request.

Section 10. Indemnification Insurance. Meals On Wheels Senior Services assumes risk of loss or injury to property or persons arising from any of its operations under this agreement and agrees to indemnify and hold harmless the City from all claims, demands, suits, judgments, costs or expenses, including expenses of litigation and attorney's fees, arising from any such loss or injury. It is expressly understood that the foregoing provisions shall not in any way limit the liability of Meals On Wheels Senior Services. Meals On Wheels Senior Services shall require that all drivers carry at all times, in the vehicle, insurance certificates of financial responsibility.

Section 11. Assignment. No assignment, transfer, subletting, conveyance or disposition of this agreement or any right occurring under it shall be made in whole or in part by Meals On Wheels Senior Services without the prior written consent of the City Council. In the event Meals On Wheels Senior Services assigns, transfers, sublets, conveys, or disposes of this agreement without the prior consent of the City Council, the City may, at its discretion, terminate this agreement.

Section 12. Venue. This agreement shall be considered consummated in Rockwall County, Texas. All actions brought hereunder shall be brought in Rockwall County, Texas.

MEALS ON WHEELS SENIOR SERVICES

Margie VerHagen, Executive Director

Date

ATTACHMENT A

Nutritional / Service Programs

Nutritional Programs

Title III

C-1 Congregate Meals

- Clients over 60 years old receive nutritious meals at a Senior Center.
- Meals should provide 1/3 of the RDA nutrition requirements.
- Meals are served a minimum of 250 days a year.

C-2 Home Delivered Meals

- Meals delivered to eligible homebound seniors due to physical or health reasons.
- Meals should provide 1/3 of the RDA nutrition requirements.
- Meals are delivered a minimum of 250 days a year.

Title IXX and XX

To provide nutritious meals to those who are handicapped or disabled (of any age) and home bound.

- Meals should provide 1/3 of the RDA nutrition requirements.
- Meals are delivered a minimum of 250 days a year as needed.

General Senior Services

Information and educational seminars and symposiums will be sponsored by Meals On Wheels Senior Services concerning benefits counseling, prescription drugs, senior health, training sessions, caregiver support and information, referrals, social events as venues for information and education exchange, ombudsman services, entitlement programs and senior issues, i.e. Medicare/Medicaid information and pharmaceutical assistance, and emergency food bags in the winter.

ATTACHMENT B Holidays

The following are closure days for which Meals On Wheels Senior Services will not be providing services but will render services the following working day:

Thanksgiving Day
Christmas Day
New Year's Day
Martin Luther King, Jr. Holiday
Memorial Day
July 4th
Labor Day

Bad Weather days as determined by Meals On Wheels Senior Services pending weather reports and street conditions.



City of Rockwall
The New Horizon

MEMORANDUM

TO: Rockwall City Council

FROM: Joey Boyd, Assistant City Manager

DATE: September 22, 2024

SUBJECT: Interlocal Agreement for Animal Control Services

The City of Rockwall performs animal control services for the Cities of Rockwall, Heath, and Rockwall County. The City of Rockwall originally entered into an agreement for animal control services with Rockwall County in July 1996. Since then, the City has constructed a new animal adoption center and shelter, privatized the operations of the shelter, expanded its service area through growth of the city, and changed certain fees related to providing animal control services.

The current Interlocal Agreement with Rockwall County expires in November 2023. An updated Interlocal Agreement for Animal Control Services between the City of Rockwall and Rockwall County is provided for the City Council's review and consideration. This updated agreement specifies the services the City will provide to Rockwall County. The agreement will run through September 30, 2024 and then renews annually upon approval by both parties.

The City Council is asked to consider authorizing the City Manager to execute the agreement on behalf of the City.

INTERLOCAL AGREEMENT FOR ANIMAL CONTROL SERVICES

THE STATE OF TEXAS

COUNTY OF ROCKWALL

THIS AGREEMENT is made and entered into by and between **ROCKWALL COUNTY, TEXAS**, (hereinafter referred to as "County") and the **CITY OF ROCKWALL, TEXAS**, a Texas Municipality (hereinafter referred to as "Client" or "City").

I. RECITALS

WHEREAS, CHAPTER 791 of the TEXAS GOVERNMENT CODE, also known as the INTERLOCAL COOPERATION ACT, authorizes all local governments to contract with each other to provide a governmental function or service that each party to the contract is authorized to perform individually and in which the contracting parties are mutually interested, such as animal control assistance and public health and welfare; and

WHEREAS, the City of Rockwall is a Home Rule municipality organized under the laws of Texas and is authorized to enter into this Agreement pursuant to the Texas Local Government Code; and

WHEREAS, Rockwall County is a political subdivision of the State of Texas, duly organized and functioning in accordance with the laws of the State of Texas; and

WHEREAS, the County and the City represent that each is independently authorized to perform the functions contemplated by this Agreement; and

WHEREAS, City operates and performs Animal Control Services, as defined herein, for the purpose of reducing general animal control problems in the City, including, but not limited to, protecting its citizens from the dangers and problems associated with free roaming animals; and

WHEREAS, the City and County entered into an Interlocal Agreement in July 1996 outlining the duties and responsibilities of the City in performing certain Animal Control Services in the County per the request of the County; and

WHEREAS, County and City wish to continue the services under the original Interlocal but have determined a need to update the original agreement because the County still has a need for such Animal Control Services; and

WHEREAS, each party anticipates sufficient funds available from current revenues to perform the functions contemplated by this Agreement; and

WHEREAS, both the County and the City find it mutually desirable to enter into this Agreement.

NOW, THEREFORE in consideration of the mutual benefits and promises each to the other made herein, the parties named above do hereby agree as follows:

II. DEFINITIONS

- A. Animal(s): “Animal(s)” shall mean domesticated dogs and cats.
- B. Animal Control Authority: “Animal Control Authority” shall mean the City of Rockwall Animal Control Department. The terms “Animal Control Authority” and “Animal Control Department” are synonymous.
- C. Animal Control Personnel: “Animal Control Personnel” shall mean any employee of the City of Rockwall Animal Control Department.
- D. Animal Control Services: “Animal Control Services” shall mean the specific services provided by the City of Rockwall Animal Control Department in response to County-Reported Animal Calls that are necessary to effectively carry out an animal control program for the County. Animal Control Staff will only respond to emergency calls in the County. Emergency calls are defined in Section III. B. Animal Control Services shall NOT include the removal of deceased animals from areas within the County’s jurisdiction. Animal Control Services shall not include any type of services for feral cats.
- E. Animal Shelter: “Animal Shelter” shall mean the City of Rockwall owned facility located at 1825 Airport Rd. or any location designated by the City Manager or designee in the event of an emergency.
- F. Unincorporated County Areas: “Unincorporated County areas” shall mean any address or location within Rockwall County that is NOT located within another jurisdictional boundary of any duly recognized municipality. For purposes of this agreement, “unincorporated county areas” do not include areas within established municipal utility districts.
- G. Dangerous Wild Animal: “Dangerous Wild Animal” shall mean animals as defined by the Texas Health and Safety Code, Chapter 822. Specific examples that may apply locally would include but not limited to cougar, bobcat, lynx, coyote, or any hybrid listed in Section 822.101.

III. CITY'S OBLIGATIONS

- A. City agrees to provide specific Animal Control Services to County occurring within the unincorporated county areas as defined above in Article II(F).
- B. The City will confirm at least one (1) Animal Control Personnel in response to a County request for Animal Control Services, so long as there is at least one (1) Animal Control

Personnel “on duty”. If there is no Animal Control Personnel on duty, the City dispatch will notify County that there are no personnel available to accept the animal. In that event, County may determine if the call is an emergency and notify the City’s Animal Control Supervisor of the emergency call. The Animal Control supervisor, at his/her sole discretion, can decide to provide at least one (1) Animal Control Personnel to respond to the emergency call. Emergency calls are defined as follows:

- Animal bites and scratches from animals without an owner.
- Aggressive animals without an owner.
- Public safety arrest that leaves an animal without supervision.
- Injured domestic animals without an owner.
- Any situation deemed an emergency by the Animal Control supervisor.

- C. City will respond only to calls directly reported by the County.
- D. City agrees to accept all captured “animals” transported to the City’s facility by Animal Control Personnel. Wild or trapped animals will not be accepted by the City and should be released back into their natural habitat by County or City if they have not caused a bite to a human.

IV. COUNTY’S OBLIGATIONS

- A. County agrees to receive all calls for Animal Control Services from citizens in the County’s jurisdiction to determine if Animal Control Services are needed. If animal control is needed, the County will contact Rockwall Police dispatch. County shall not direct or advise citizens to call the City for Animal Control Services.
- B. County shall fully cooperate with City in the provision of Animal Control Services, including but not limited to, furnishing: any and all information in its possession about the ownership of a suspected rabid Animal, including Rabies Vaccination Certificates maintained by any department of the City; any history of the Animal; the name and address of any person reporting an Animal bite or scratch; the name and address of any possible victims of an Animal bite or scratch; and the name and address of any person believed to own an Animal which the County has called the City to house.
- C. County agrees to transport all Animals found within the unincorporated county areas in an approved, properly functioning live animal cage prior to admittance into the City’s Animal Shelter.
- D. County agrees to pay all fees associated with the impoundment or final disposition of any animal found within the unincorporated county areas per this Agreement.
- E. The County shall be responsible for any veterinarian bills incurred regarding animals from the unincorporated county areas that are transferred to a County approved Veterinary Clinic, who require immediate medical attention prior to transporting the animal to the City’s Animal Shelter. All required billing and treatment communications shall be transmitted directly from the veterinarian to the County.

V. CONSIDERATION

- A. In consideration for the City's performance of the duties listed herein, the County agrees to pay the City for the services, as delineated in this Agreement, according to the fee schedule attached hereto as Exhibit A. Such fee schedule may be amended by the City through its annual budget process. City shall provide a copy to the County of any fees adjusted per the City's budget.
- B. The fee schedule in Exhibit A only applies to requested services upon intake and does not reflect specific services required for the final disposition of any Animal after intake. County shall pay actual costs for the disposition of any animal.

VI. DEFAULT

- A. In the event County fails to: (i) pay all costs set forth in Article V above, or (ii) perform its obligations as set forth in Article IV, the City shall give County written notice of default with an opportunity to cure such default within thirty (30) days. If County fails to cure such default during the 30-day cure period, the Agreement shall terminate and County shall assume responsibility for its own animal control operation.
- B. In the event City fails to perform its obligations as set forth in Article III, the County shall give City written notice of default with an opportunity to cure such default within thirty (30) days. If City fails to cure such default during the 30-day cure period, the Agreement shall terminate and County shall assume responsibility for its own animal control operation.

VII. TERMINATION AND RENEWAL

- A. This Agreement shall be effective from the date last signed below, through September 30, 2024. This Agreement shall be renewed annually thereafter for additional one (1) year terms to run from October 1st to September 30th. The Agreement will be renewed upon full review of the Services provided herein and upon written approval by both parties.
- B. This Agreement may be terminated by either party upon sixty (60) days written notice to the other party. All costs and liabilities incurred by the City on behalf of the County prior to the termination shall be the responsibility of the County.

VIII. INDEMNITY

Subject to the limitations as to liability and damages in the Texas Tort Claims Act and without waiving its governmental immunity, each Party agrees to hold harmless each other, its governing board, officers, agents and employees for any liability, loss, damages, claims or causes of action caused or asserted to have been caused directly or indirectly by any other Party to this Agreement,

or any of its elected officials, officers, agents or employees, or as the result of its performance, or any of its officers, agents or employees, under this Agreement.

IX. INDEPENDENT CONTRACTOR

- A. The City shall be responsible for the Animal Control Services contemplated under this Agreement. The City shall supply materials, equipment, tools, transportation, and labor required for or reasonably incidental to the performance of Animal Control Services. The City shall have ultimate control over the execution of the work under this Agreement. The City shall have the sole obligation to employ, direct, control, supervise, manage, discharge, and compensate all of its employees.
- B. The City shall have full authority for the final disposition of any animal submitted by County.

X. GENERAL PROVISIONS

- A. The parties intend for the various provisions of this Agreement to be severable so that the invalidity, if any, of any one section (or more) shall not affect the validity of the remaining provisions or sections.
- B. This document may be executed in any number of original signature counterparts, each of which shall for all purposes be deemed an original, and all such counterparts shall constitute one and the same document.
- C. Each party has the full power and authority to enter into and perform this Agreement, and the person signing this Agreement on behalf of each party has been properly authorized and empowered to enter into this Agreement. The persons executing this Agreement hereby represent that they have authorization to sign on behalf of their respective entity.
- D. This Agreement shall be interpreted in accordance with the laws of the State of Texas and venue shall be in Rockwall County, Texas.
- E. Any notice required under the provisions of this Agreement shall be in writing and delivered in person or deposited in the United States Mail, registered or certified, return receipt requested. Any such notice must be addressed to the following addresses. Any notice shall be deemed received three days after the date of deposit in the United States Mail, unless proof is offered to the contrary. Unless otherwise provided in this Agreement, all notices shall be delivered to the following addresses:

**City of Rockwall
385 S. Goliad St
Rockwall TX, 75087**

**Rockwall County
101 E Rusk St
Rockwall, TX, 75087**

- F. Amendment: This Agreement may not be amended except by written instrument specifically referring to this Agreement and signed by the parties hereto.
- G. Binding Agreement: This Agreement has been duly executed and delivered by both parties and constitutes a legal, valid, and binding obligation of the parties. Each person executing this Agreement on behalf of each party represents and warrants that they have full right and authority to enter into this Agreement.
- H. Joint Venture and Agency: The relationship between the parties to this Agreement does not create a partnership or joint venture between the parties. This Agreement does not appoint any party as agent for the other party.
- I. Approval by Governing Bodies. This Agreement has been approved by the governing bodies of the City and of the County.
- J. Payment from Current Revenues. Each Party paying for the performance of governmental functions or services must make those payments from current revenues available to the paying Party.
- K. Entire Agreement: This Agreement contains the entire agreement between the parties and correctly sets forth the rights, duties, and obligations of each to the other as of the Effective Date. Any oral representations or modifications concerning this Agreement will be of no force or effect excepting a subsequent written modification executed by both parties.

EXECUTED TO BE EFFECTIVE this _____ day of _____, 2023.

ROCKWALL COUNTY, TEXAS

By: _____
County Judge

CITY OF ROCKWALL, TEXAS

By: _____
Mary Smith, City Manager

ATTEST:

Kristy Teague, City Secretary

EXHIBIT A

FEE SCHEDULE:

- A. The City shall bill the County at a rate of forty dollars (\$40) per hour to defray the costs of resources and employee time utilized. There will be a minimum of two (2) hour charge if an officer is called out after regular business hours. For purposes of this agreement, regular business hours shall be 8:00 a.m. to 5:00 p.m., Monday through Friday.

- B. A thirty dollar (\$30) impound fee, for the first 24-hour period, will be paid by the owner of each animal released from the shelter to the owner, plus ten dollars (\$10) per day per animal for each additional 24-hour period. This fee applies to Rockwall County residents within unincorporated areas of the County as defined by this agreement. All others shall comply with the City and Animal Shelter's adopted policies.

- C. The County shall pay ten dollars (\$10) per day to the City for each "animal" received from the County for impoundment. This fee shall NOT apply to the first 200 "animals" received on an annual basis. Invoices are based on net 30 days payment.



CITY OF ROCKWALL, TEXAS MEMORANDUM

TO: Honorable Mayor and City Council

**CC: Mary Smith, City Manager
Joey Boyd, Assistant City Manager
Misty Farris, Purchasing Agent**

FROM: Travis E. Sales, Director Parks, Recreation and Animal Services

DATE: October 2, 2023

SUBJECT: Solar lighting installation at Kidzone and parking lots at Harry Myers Park

This project is for the installation of solar area and solar parking lot lights at three location within Harry Myers Park. The total cost of this project is \$165,280.80 to be funded out of the Recreation Development Fund. This is an approved 2023-2024 budget request budgeted at \$185,000.00 for all three projects

The quote is provided by Facility Solutions Group / Green Frog System under BuyBoard Contract # 657-21. Facility Solutions Group / Green Frog Systems has provided us with test lights that we tested for last several years. These lights have been great, and we have purchased additional lights that have been in service for 5 plus years with no issues. Facility Solutions Group / Green Frog Systems also participated in the Leadership Rockwall Project at Lofland Park by donating similar lights with no issues and the results have exceed expectations in all applications.

As a member and participant in the Buy Board cooperative program, the City has met all formal bidding requirements pertaining to the purchase and install of the poles, solar panels and lights.

For Council consideration is this solar lighting project bid award to the above listed vendor for the respective dollar amounts and authorize the City Manager to execute purchase orders and/or contracts for this project.



FSG Dallas
 2525 Walnut Hill Ste 300
 Dallas, TX 75229
 214-217-0190
 chad.jones@fsgi.com

Remit to Address:
 Facility Solutions Group, Inc
 P.O. Box 200942
 Dallas, TX 75320-0942

Quote# 5385174-00

Customer#: 715971-0002

Invoice Date:
 Due Date :

Ship to:
 Hary Myers Park

Bill to:

City of Rockwall
 Attn: Accounts Payable
 385 S. Goliad
 Rockwall, TX 75087

815 E Washington Street
 Rockwall, TX 75087

Cust PO #:
 Phone :
 Placed By:
 Brand:

Order Date: 09/13/23
 Ship Date:

Ship Via: Best Way
 Instructions: BuyBoard #657-21

Terms: COD

Ln	Product	Ordered	BackOrd	Shipped	QU/M	UnitPrice	PU/M	Amount
**** <u>50% down payment required</u> ****								
1	AEROMAX-PRO-BK AEROMAX PRO Solar Module (Requires LED&Arm) 110Wp solar panel 108Ah 1382.4Wh LiFePO4 battery Warranty 10+25+10 years Black	11			EA	2550.90	EA	28,059.90
2	GFS-AER-10653-PIR-BK AEROMAX LED Fixture 4-60W T3 optics 4000K 0-16W PIR Black	11			EA	460.90	EA	5,069.90
3	POLE-CUSTOM 4' Arm For The AeromaX Fixture	11			EA	275.00	EA	3,025.00
4	STEALTH5-4K STEALTH Solar Light. 1-29W(max) plus 21W PIR, 4K CCT Light, 65Wp Panel, 461 Wh LiFePO4 Battery. Warranty 5 years / 25 year solar panel / 10 year battery performance (Requires pole or wall mount)	28			EA	1870.00	EA	52,360.00
5	GFS-STE-PMB7 Pole Mount Bracket	28			EA	110.00	EA	3,080.00
6	RV-2-BK BULLHORN RV-2-BK BULLHORN	7			EA	187.00	EA	1,309.00
7	RSPDB-19.10-4.5-11-BL RSPDB-19.10-4.5-11-BLK-T 2 Round Straight Pole, Direct Bury	14			EA	621.50	EA	8,701.00
8	14' Bolt Down Pole RSSP-14-4R-11G-9BC-BLK-3 430	7			EA	816.75	EA	5,717.25
9	16' Bolt Down Pole RSSP-16-4R-11G-9BC-BLK-3 430	11			EA	866.25	EA	9,528.75
10	LABOR INSTALLATION	1			EA	45750.00	EA	45,750.00
10	Lines Total	Qty Shipped Total		129		Total		162,600.80
						Shp/Hand-In		2,680.00
						Invoice Total USD		165,280.80

On all sums due, which have not been paid, Customer agrees to pay a calculated service charge of 1.5% per month (not exceeding the highest amount lawfully allowed by contract in this state). If litigation commences to collect payment of amounts due, Customer agrees to pay reasonable attorneys' sums which may be due



FSG Dallas
2525 Walnut Hill Ste 300
Dallas, TX 75229
214-217-0190
chad.jones@fsgi.com

Remit to Address:
Facility Solutions Group, Inc
P.O. Box 200942
Dallas, TX 75320-0942

Quote# 5385174-00

Customer#: 715971-0002

Invoice Date:
Due Date :

Ship to:
Hary Myers Park

Bill to:

City of Rockwall
Attn: Accounts Payable
385 S. Goliad
Rockwall, TX 75087

815 E Washington Street
Rockwall, TX 75087

Cust PO #:
Phone :
Placed By:
Brand:

Order Date: 09/13/23
Ship Date:

Ship Via: Best Way
Instructions: BuyBoard #657-21

Terms: COD

Table with columns: Ln, Product, Ordered, BackOrd, Shipped, QU/M, UnitPrice, PU/M, Amount

Special Order / Non-stock Acknowledgement

This order contains special order items which may not be returnable to the manufacturer or may require restock fees upon return. By signing this quote, customer verifies that this order contains complete specifications, options and accessories. Customer authorizes Facility Solutions Group to place the order and agrees to pay all freight charges incurred from the manufacturer as well as any restock fees and freight charges incurred if returned.

Signature

Printed Name

Date

All Quotes are valid for 30 days from date of issue. Quotation is subject to FSG Standard Terms and Conditions: HTTPS://fsg.com/terms-and-conditions

** Remit to Facility Solutions Group, Inc. P.O. Box 200942 Dallas, TX 75320-0942
Pay by Check,ACH,*Credit Card. Email ar@fsgi.com. Call (512) 440-7985 to pay by ACH/*Credit Card
*3% Surcharge is added to Credit Card pymts that is not greater than our cost of acceptance.
With this purchase, customer agrees to transfer the capacity rights of the demand savings.

On all sums due, which have not been paid, Customer agrees to pay a calculated service charge of 1.5% per month (not exceeding the highest amount lawfully allowed by contract in this state). If litigation commences to collect payment of amounts due, Customer agrees to pay reasonable attorneys' sums which may be due



CITY OF ROCKWALL, TEXAS MEMORANDUM

TO: Honorable Mayor and City Council

CC: Mary Smith, City Manager
Joey Boyd, Assistant City Manager
Misty Farris, Purchasing Agent

FROM: Travis E. Sales, Director Parks, Recreation and Animal Services

DATE: October 2, 2023

SUBJECT: Basketball Courts and Pickleball Court Resurfacing

This project is for the repair of cracks and resurfacing of basketball courts at Gloria Williams and Northshore Parks. This project also is for the resurfacing of Hickory Ridge Pickleball Courts, which need resurfacing due to the high use and popularity of pickleball. The total cost of this project is \$55,000.00 to be funded out of the Recreation Development Fund. This is an approved 2023-2024 budget request budgeted at \$55,000.00.

The quote is provided by Master System Courts under BuyBoard Contract # 641-21. Master System Courts has surfaced our new courts, resurfaced existing courts and the results have exceed expectations in all applications.

As a member and participant in the Buy Board cooperative program, the City has met all formal bidding requirements pertaining to the purchase and installation of products and labor to resurface the above-mentioned courts.

For Council consideration is this court resurfacing project bid award to the above listed vendor for the respective dollar amounts and authorize the City Manager to execute purchase orders and/or contracts for this project.



August 27, 2023

Travis E. Sales
City of Rockwall
Park Superintendent
108 E. Washington
Rockwall, TX 75087
Mobile: 972-772-6332
Email: TSales@rockwall.com

Dear Travis:

Thank you for the opportunity to resurface playing courts for the City of Rockwall. Master Systems is known for its tradition of integrity, craftsmanship and unparalleled service before and after the sale. Master Systems proposes to provide material, labor and insurance to complete the project in a professional and timely manner.

The price for the following court services are as follows: Per attached specification

Pickleball

Resurface three (3) courts –Hickory Ridge Park – 1910 Walnut Ridge Dr., Rockwall, TX 75032
Colors: Returning to “Gray” apron and kitchen colors “Maroon” playing area and “White” playing lines.

Basketball

Resurface two (2) basketball courts.
Colors: Returning to “Gray” court “White” playing lines.

North Shore Park – 609 Highland Dr., Rockwall, TX 75087 – Half Basketball Court (approx area 60’x 45’)
Gloria Willims Park - 807 Davey Crockett Dr., Rockwall, TX 75087 – Full Basketball Court (approx area 90’x 50’)

Price \$55,000.00 Decline _____ Accept _____

This proposal is valid until October 3, 2023 whereupon a review of costs will be made. Scheduling can begin immediately upon approval. The property owner is responsible for onsite power and water.

Terms: 50% due upon order • 50% upon completion. Tax not included. Tax will be added to final invoice.

Please call if you have any questions. It will be a pleasure working with you.

Sincerely,

Blair Descourouez
Master Systems Courts
Buy Board # 641-21

PROPOSAL ACCEPTED

By: _____

Descourouez LLC DbA Master Systems

Representing: _____

By: _____

Date: _____

Date: _____



"MASTER COURT SPECIFICATION" ONE COURT

STANDARD IN STOCK COLORS WITH OFFICIAL PLAYING LINES

- CLEAN COURT TO REMOVE DIRT, LOOSE SURFACE, AND WATER STAINS.
- FILL CRACKS WITH ACRYLIC CRACK FILLER.
- PRIME ALL PATCHES WITH BONDING COAT.
- APPLY ACRYLIC RESURFACER TO COURT AS NEEDED TO PROVIDE A UNIFORM SURFACE.
- APPLY TWO (2) COATS FORTIFIED 100% ACRYLIC FINISH SYSTEM FOR THE IDEAL COLOR AND PLAYING SURFACE.
- ADD 2" TEXTURED WHITE PLAYING LINES PER SPECIFICATIONS.

THIS "MASTER" SYSTEM IS VIRTUALLY MAINTENANCE FREE, RICH IN COLOR AND REQUIRES NO PROLONGED CURING TIME. THE RESURFACING LIFE IS APPROXIMATELY 5 YEARS DEPENDING ON THE FORCES OF NATURE, PROPER MAINTENANCE AND DRAINAGE. CRACKS AND LOW SPOTS "BIRD BATHS" WILL REAPPEAR. ALLOWING PLAY ON THE COURTS CONSTITUTES ACCEPTANCE OF WORK. SAW CUTS & EXPANSION JOINTS WILL REMAIN VISIBLE AFTER APPLICATION. NO WARRANTY ON EXPANSION JOINTS, SAW CUTS, LOW SPOTS OR CRACKS. NO WARRANTY ON ASPHALT COURTS.

The work will be warranted for a period of one year from the date of completion. Our guarantee will protect against the inadequate adhesion of the acrylic coating due to workmanship or product reliability. Warranty does not cover courts built without post tension cables or vapor barrier. Warranty does not cover cracks, low spots, drainage issues & improper slope, water seepage, leaching, slick concrete, inadequate adhesion and surface bubbling. We are not liable for blisters or delamination of coatings caused by low spots, coating build-up and lack of vapor transmission. Warranty does not cover foundation cracking, separation of pavement structure, depressions in slab or in the sub-base of the court. Irrigation left on around court leading to damaged paint during installation will lead to extra costs. It is not possible to warrant against vandalism, surface chips from improper use of court including but not limited to bicycles or skateboards.

Terms: 50% upon order · 50% upon completion

Failure to make timely payments to the Contractor will immediately void all warranties.

Scheduling of work can begin immediately upon approval.

Certificate of insurance available upon request

Construction · Resurfacing · Equipment

972.620.9540

MasterSystemsCourts.com



CITY OF ROCKWALL, TEXAS MEMORANDUM

TO: Honorable Mayor and City Council

CC: Mary Smith, City Manager
Joey Boyd, Assistant City Manager
Misty Farris, Purchasing Agent

FROM: Travis E. Sales, Director Parks, Recreation and Animal Services

DATE: October 2, 2023

SUBJECT: Toro Dingo XT1000 with landscape attachment

This request is for the purchase of a Toro Dingo XT1000, and the total cost of this unit is \$48,081.90 to be funded out of the Parks Operating Budget. This is an approved 2023-2024 budget request budgeted at \$55,000.00

The quote is provided by Horizon Online Distributors under SOURCEWELL CO-OP CONTRACT NUMBER 031121-TTC.

As a member and participant in this cooperative program, the City has met all formal bidding requirements pertaining to the purchase and install of products and labor to resurface the above-mentioned courts.

For Council consideration is this equipment purchase bid award to the above listed vendor for the respective dollar amounts and authorize the City Manager to execute purchase orders and/or contracts for this project.



H222-BEDFORD-HDI
 3717 COMMERCE PL STE A
 BEDFORD, TX 76021-6022
 Phone 817-545-7756
 Fax 817-545-9407

Quotation

THIS IS NOT AN INVOICE

QUOTE #	5Y003175
LOCATION	H231
DATE	09/11/23
PAGE	1 of 1

BILL TO

H33226
 NTX EQUIPMENT SALES
 3717 COMMERCE PL
 BEDFORD, TX 76021-6022
 Phone 972-266-6184

SHIP TO

CITY OF ROCKWALL
 108 E WASHINGTON ST
 ROCKWALL, TX 75087-3715

QUOTE DATE 09/11/23	EXPIRE DATE 10/11/23	REQUIRED DATE	REFERENCE NUMBER	PAYMENT TERMS CTR: CHECK OK
WRITTEN BY S JOHN MCMAHAN(H222)			CONTACT TRAVIS SALES	SHIP VIA BEST METHOD
FREIGHT TERMS IN/OUTBOUND			JOB NUMBER	SALES REP H222/

PRODUCT/DESCRIPTION	QUANTITY	PRICE	U/M	EXTENSION
TOC-59-1245 22327 24.9HP KUBOTA DIESEL NARROW DINGO TX1000 UTIL LOADR	1	39,483.10	EA	39,483.10
TOC-59-1015 22409 4.3CUFT STANDARD BUCKET	1	842.45	EA	842.45
TOC-59-1181 23102 SOIL CULTIVATOR SOURCEWELL CO-OP CONTRACT NUMBER 031121-TTC	1	7,756.35	EA	7,756.35

MERCHANDISE TOTAL	HANDLING	MISC CHARGE	TAX	FREIGHT	QUOTE TOTAL
48,081.90	0.00	0.00	3,966.76	0.00	52,048.66

Accepted:

By: _____
 Date: _____



City of Rockwall
The New Horizon

MEMORANDUM

TO: Rockwall City Council

FROM: Joey Boyd, Assistant City Manager

DATE: September 22, 2023

SUBJECT: Amendment with Rockwall Adoption Center for FY 24 Funding

The City Council approved the Fiscal Year 2024 budget at its meeting on Monday, September 18, 2023, which included additional operating funds for Rockwall Adoption Center, the organization that has been running the daily operations of the City's animal adoption center since 2012. This partnership has been beneficial to the City and the Rockwall community.

As part of the budget process, Mrs. Brodnax requested an increase in operating funds due to a rise in costs of operations and delivery of services. The contract currently allocates \$410,471.50 for operations and is proposed to increase to \$480,000 annually. This is a \$69,500 increase over the previous fiscal year and is the first increase requested by RAC since the inception of their contract in 2012.

The contract amendment for your review and consideration formally increases the operating amount specified in the contract to reflect the \$480,000 that was already approved in the FY 24 operating budget. The City Council is asked to consider authorizing the City Manager to execute the amendment on behalf of the City.

Animal Shelter and Adoption Services Agreement by and between
The City of Rockwall, Texas
And
Collin County Humane Society
Assigned to Rockwall Adoption Center

This Amendment is to the **Animal Shelter and Adoption Services Agreement** (hereinafter referred to as the "Agreement") which was entered into by and between **the City of Rockwall** (hereinafter referred to as the "City") and **Rockwall Adoption Center** (hereinafter referred to as the "Center") in July 2012, but which was assigned in December 2016 to **Rockwall Adoption Center (and hereafter referred to as "RAC")**, City, Center and RAC are collectively referred to in this Amendment as the "Parties."

W I T N E S S E T H

WHEREAS, in 2008, the City of Rockwall ("City") opened a 7000 square foot Animal Adoption Center (hereinafter the "RAAC") to accept and care for dogs, cats, and other animals surrendered by the public; and together with other partners and volunteers in the community, the RAAC provides adoption services, licensing of dogs in accordance with law, assistance in rabies vaccination services with local veterinarians, and promotes the humane treatment of animals; and

WHEREAS, in 2012 the City transferred operation of the RAAC to the Collin County Humane Society by establishing a partnership between the City of Rockwall and the Collin County Humane Society with each party clearly understanding its roles and responsibilities as set forth in the Agreement; and

WHEREAS, the Collin County Humane Society Amended its Agreement with the City in September 2015 to assist the parties in providing services to the citizens of Rockwall when the Collin County Humane Society agreed to have the ability to receive and answer all incoming phone calls related to City of Rockwall Animal Control if desired; and

WHEREAS, in a letter dated October 12, 2016, the Collin County Humane Society requested that the current contract and amendment be assigned and assumed by the Rockwall Adoption Center (dba Legacy Humane Society) and such change will assist in IRS reporting, fundraising efforts, and also help with grant applications and that the current contract be extended by an additional five year term extending the Agreement until **December 1, 2024**; and

WHEREAS, on December 2016, the City of Rockwall approved the assignment from the Collin County Humane Society to Rockwall Adoption Center;

NOW THEREFORE, in consideration of the mutual covenants and agreements contained herein, the Parties hereby agree as follows:

SECTION 1. AMENDMENT. In accordance with Article VI, Section 11 of the Agreement, the City and RAC agree to this Amendment. Changes of the original Agreement is an integral part of the Agreement and the purpose of this Amendment is to incorporate the following changes to the Agreement:

III. CITY RESPONSIBILITIES

5. Funding and Payment. The City will fund the actual costs incurred by the Humane Society in the performance of its obligations pursuant to this Agreement in an amount up to, but not to exceed, \$480,000 annually. Beginning on the date of the contract execution, the City will make quarterly payments in the amount of \$120,000 with the first installment payment due on the commencement date. The amount of this subsidy will remain constant throughout the Term, unless a different amount is mutually agreed upon by the Parties in writing. Upon the expiration or earlier termination of this Agreement, any unspent or unobligated funds will be immediately returned to the City by the Humane Society.

SECTION 2. AGREEMENT NOT OTHERWISE AMENDED. Except as set forth in this Amendment outlined in Section 1, the Agreement, is not otherwise amended and remains in full force and effect.

SECTION 3. GOVERNING LAW. This Amendment shall be construed in accordance with the laws of the State of Texas and venue shall be in Rockwall County.

IN WITNESS WHEREOF, the parties have executed this Amendment and cause the Amendment to be effective on the latest day as reflected by the signatures below.

ROCKWALL ADOPTION CENTER

CITY OF ROCKWALL, TEXAS

By: _____

By: _____

Name: Molly Broadnax
Title: President

Name: Mary Smith
Title: City Manager

Date: _____

Date: _____

ATTEST:

By: _____
Kristy Teague, City Secretary

Rockwall

Central Appraisal District

September 8, 2023

CITY OF ROCKWALL
MAYOR TRACE JOHANNESSEN
385 S GOLIAD
ROCKWALL, TX 75087

Texas Property Tax Code Sec. 6.03(a): The Appraisal District is governed by a board of directors. Five directors are appointed by the taxing units that participate in the district as provided by this section . . . To be eligible to serve on the board of directors, an individual . . . must be a resident of the district and must have resided in the district for at least two years immediately preceding the date the individual takes office.

Texas Property Tax Code Sec. 6.03(d): The voting entitlement of a taxing unit that is entitled to vote for directors is determined by dividing the total dollar amount of property taxes imposed in the district by the taxing unit for the preceding tax year by the sum of the total dollar amount of property taxes imposed in the district for that year by each taxing unit that is entitled to vote, by multiplying the quotient by 1,000, and by rounding the product to the nearest whole number. That number is multiplied by the number of directorships to be filled.

Texas Property Tax Code Sec. 6.03(g): Each taxing unit . . . that is entitled to vote may nominate by resolution adopted by its governing body one candidate for each position to be filled on the board of directors. The presiding officer of the governing body of the unit shall submit the names of the unit's nominees to the chief appraiser before October 15.

Texas Property Tax Code Sec. 6.03(j): Before October 30, the chief appraiser shall prepare a ballot, listing the candidates whose names were timely submitted under Subsection (g) . . . alphabetically according to the first letter in each candidate's surname, and shall deliver a copy of the ballot to the presiding officer of the governing body of each taxing unit that is entitled to vote.

Attached is a list reflecting each taxing unit's number of votes.

Current Appointed Members are:

Vicki Alexander
John Brandt
John Hohenshelt
Lorne Liechty
Russell Summers

2024 – 2025 Rockwall Central Appraisal District Board of Directors Election

Entity	Number of Votes
City of Dallas	0
City of Fate	105
City of Garland	0
City of Heath	120
City of McLendon-Chisholm	15
City of Rockwall	380
City of Rowlett	95
City of Royse City	120
City of Wylie	10
Rockwall ISD	2685
Royse City ISD	640
Rockwall County	825

**CITY OF ROCKWALL
RESOLUTION NO. 23-09**

**A RESOLUTION OF THE CITY COUNCIL OF THE CITY OF
ROCKWALL, TEXAS, PROVIDING FOR SUBMISSION OF
NAMES FOR BOARD MEMBER NOMINATIONS TO THE
ROCKWALL CENTRAL APPRAISAL DISTRICT (CAD)
BOARD OF DIRECTORS FOR 2024-2025; PROVIDING
FOR AN EFFECTIVE DATE.**

WHEREAS, Texas Property Code Sec. 6.03 (a) provides that a board of directors governs the central appraisal district (CAD); and

WHEREAS, state law requires board of director appointments to the Rockwall CAD Board every odd numbered year to take office in even numbered years; and

WHEREAS, eligible taxing units participate in the appointment process by nominating up to five candidates for service consideration and submitting those names to the chief appraiser by October 15; and

WHEREAS, the chief appraiser will then prepare a ballot of all nominees and deliver it to the presiding officer of the governing body of each of the taxing units for voting by October 30; and

WHEREAS, a taxing unit's entitlement is determined by dividing the total dollar amount of property taxes imposed in the district by the taxing unit for the preceding tax year by the sum of the total dollar amount of property taxes imposed in the district for that year by each taking unit entitled to vote, by multiplying the quotient by 1,000 and rounded to the nearest whole number; and

WHEREAS, according to the chart contained within the letter dated September 8, 2023, and mailed to the City of Rockwall by the appraisal district, the City of Rockwall will have 380 votes.

NOW, THEREFORE, BE IT RESOLVED BY THE CITY COUNCIL OF THE CITY OF ROCKWALL, TEXAS, THAT:

Section 1. the Rockwall City Council, as a result of the Executive Session held at its regular city council meeting on the 2nd day of October, 2023 hereby nominates and instructs the City Manager to send for submission to the CAD the following individuals:

1. _____
2. _____

Section 2. this Resolution shall become effective from and after its adoption and it is so resolved.

PASSED AND APPROVED BY THE CITY COUNCIL OF THE CITY OF ROCKWALL, TEXAS, THIS THE 2nd DAY OF OCTOBER, 2023.

ATTEST:

Trace Johannesen, Mayor

Kristy Teague, City Secretary



City of Rockwall
The New Horizon

MEMORANDUM

TO: Mayor and City Council Members
FROM: Hotel Occupancy Tax Sub-committee Members
Mary Smith, Assistant City Manager
DATE: September 29, 2023
SUBJECT: Request for Funding – Chamber of Commerce

The Council subcommittee requested additional information from the Chamber regarding their Visit Rockwall budget for funding for fiscal year 2024. Chamber representatives met with the subcommittee on September 27 and were asked to provide additional details regarding some of their requested programs and materials. Discussion was held regarding marketing, programming, events and other CVB related expenses. The subcommittee stressed the importance of frequent reporting to the Council and the Chamber will begin to report Quarterly in fiscal year 2024.

To summarize the Chamber’s request which was included in the notebook of requests presented to Council in August was \$465,000 which includes marketing, staffing, and the Skate the Lake event. The Council approved a two-year contract with the Chamber last year to run through fiscal year 2024 but subject to annual appropriation by the Council.

In addition, the subcommittee met with the owner of Oasis Pickleball and after discussing the tournament activities at Oasis then asked him to correct and resubmit his application for funding at a later date.

Assuming approval of this amount, the HOT budget summary is below:

Fund Balance carried forward	\$2,354,400
Projected Revenues	1,850,000
Appropriated Funding	<u>(1,118,200)</u>
Projected Fund Balance	\$3,086,200

Council is asked to consider approval of the appropriation to the Chamber of Commerce in the amount of \$465,000.



City of Rockwall

MEMORANDUM

TO: Mayor and City Council Members
FROM: Travis Sales, Parks Director
DATE: October 2, 2023
SUBJECT: Ben A. Klutts Sr. Park (Klutts Farm Park Land Donation)

The Park and Recreation Advisory Board serving in its capacity as the Park Naming Committee recommends that the City of Rockwall name the park land donation from the Klutts family at the Klutts Farm the Ben A. Klutts Sr. Park.

The Park and Recreation Board received a request from the Klutts family at the time the land was donated that the park be named after the family.

The Park and Recreation board considered the facts that Ben A. Klutts Sr. was a prominent former businessman on the downtown square in the ownership of Klutts Motor Company and Rockwall Tractor Company. He served two terms as Mayor, City of Rockwall over a span of twelve years from 1949 to 1965. He was an Honorary Member and Paul Harris Fellow of Rockwall Rotary Noon Club, having only missed one meeting in fifty years of membership. Active in community, civic affairs and Rockwall Chamber of Commerce, Mr. Klutts was an early member of North Texas Municipal District Board of Directors.

This request is supported by the facts that Ben A. Klutts Senior was a prominent citizen of the City of Rockwall for many years.

The Park and Recreation Advisory Board serving in its capacity of the Park Naming Committee provides a recommendation to the City Council to approve by resolution as outlined in the Park, Recreation and Municipal Facilities Naming policy that the City of Rockwall name the donated land Ben A. Klutts Sr. Park. This was passed with a 6-0 vote with Amanda Fowler not present.

ATTACHMENTS:

1. 23-08_NAMING Klutts Park_10-02-23

CITY OF ROCKWALL, TEXAS

RESOLUTION NO. 23 - 08

A RESOLUTION OF THE CITY COUNCIL OF THE CITY OF ROCKWALL, TEXAS, NAMING CERTAIN 50 ACRES OF DEDICATED PARK LAND THE “BEN A. KLUTTS SR. PARK;” PROVIDING FOR AN EFFECTIVE DATE.

WHEREAS, Chapter 30, Sec. 30-27(5) calls for the city’s Parks and Recreation Board to concern itself with any issue which may bear on the facilities and programs of the Parks and Recreation Department and provide such recommendations as it may deem appropriate to the city council and city staff; and

WHEREAS, the City’s “Park, Recreation, and Municipal Facilities Naming Policy” calls for the Park(s) (and Recreation) Board to act as a committee that will be responsible for recommending to the City Council a name for park land and recreation facilities; and

WHEREAS, in accordance with said policy, the Parks and Recreation Board, serving in the capacity of the Park Naming Committee, recently reviewed a request by the Klutts family to consider naming certain 50 acres of dedicated park land donated to the City of Rockwall; and

WHEREAS, in consideration of this request, the Parks and Recreation Board took into account the following facts: Ben A. Klutts, Sr. was a prominent former businessman on the downtown square in the ownership of Klutts Motor Company and Rockwall Tractor Company; He served two terms as Rockwall’s mayor over a span of twelve years from 1949 to 1965; He was an honorary member and Paul Harris Fellow of the Rockwall Noon Rotary Club, having only missed one meeting in fifty years of membership; He was active in community, civic affairs and the Rockwall Chamber of Commerce and was an early member of North Texas Municipal Water District Board of Directors; and

WHEREAS, the city’s Parks and Recreation Board reviewed the family’s request and voted 6 “in favor” with 1 absence to recommend that the City Council approve the naming of this dedicated park land.

NOW THEREFORE, BE IT RESOLVED BY THE CITY COUNCIL OF THE CITY OF ROCKWALL, TEXAS, THAT:

Section 1. the 50 acres of dedicated park land shown in “**EXHIBIT A**” of this resolution is hereby named the: “Ben A. Klutts, Sr. Park;” and

Section 2. this resolution shall be in full force and effect from and after its passage and it is accordingly so resolved.

PASSED AND APPROVED BY THE CITY COUNCIL OF THE CITY OF ROCKWALL, TEXAS THIS 2nd day of OCTOBER, 2023.

Trace Johannesen, Mayor

ATTEST:

Kristy Teague, City Secretary

EXHIBIT A

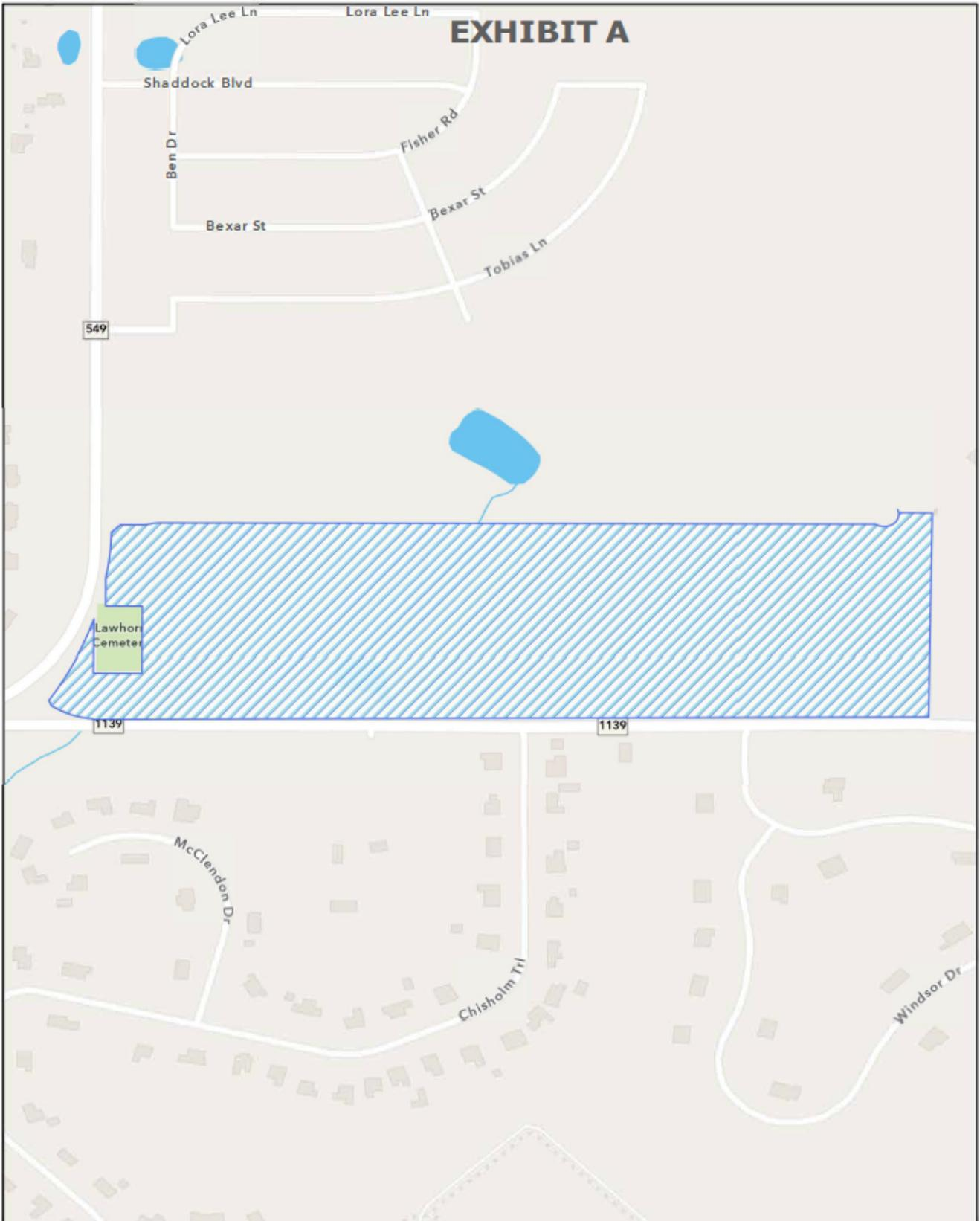

City of
Rockwell



0 250 500ft
Date: 9/11/2023

The data presented on this map was obtained with the best methods available. Data is subject to various sources and accuracy may be out of the City of Rockwell's control. The verification of accuracy and/or content is entirely with the end user. The City of Rockwell does not guarantee the accuracy of contained information. All information is provided "as is" with no warranty being made, either expressed or implied.



CITY OF ROCKWALL, TEXAS MEMORANDUM

TO: Honorable Mayor and City Council

CC: Mary Smith, City Manager
Joey Boyd, Assistant City Manager

FROM: Travis E. Sales, Director of Parks and Recreation

DATE: October 2, 2023

SUBJECT: Park and Recreation / Rockwall Baseball and Softball Association
Zero Tolerance Treatment of Umpire Policy

Attached in the packet for the Council's review and consideration is a "Zero Tolerance Policy" related to the treatment of umpires within the city's RBSL. Staff and the city's Park and Recreation Board believe that by adhering to this policy, we collectively contribute to the growth and success of our league while upholding the values of sportsmanship and fair play. The policy has been reviewed by PARD Staff, the City Attorney and the Parks and Recreation Board. This policy was passed by the Parks and Recreation Board, with a 6-0 vote to recommend its approval to Council (Park Board Member Amanda Fowler was not present).

Rockwall Baseball and Softball League’s “Zero Tolerance Treatment of Umpires” Policy

Purpose:

The Rockwall Baseball and Softball League (RBSL) is committed to providing a safe, respectful, and enjoyable environment for all participants, including players, spectators, coaches, parents, and umpires. Umpires play a crucial role in ensuring fair play and maintaining the integrity of the games. RBSL has a zero-tolerance policy for behavior that is disrespectful, discourteous, or may in any way be construed as intimidating towards its umpires. With this policy, RBSL hopes to maintain an environment in RBSL that is both umpire friendly and that teaches parents, spectators, and players to have respect for those in positions of authority. Violations of this policy will result in disciplinary actions including suspensions and potentially expulsion from RBSL. This No Tolerance Policy is designed to emphasize our dedication to treating umpires with respect and dignity.

Policy:

The RBSL enforces a strict No Tolerance Policy concerning the treatment of umpires during games and related events. All participants, including players, coaches, parents, and spectators, are expected to adhere to this policy. Any violation of this policy may result in severe consequences including and not limited to suspension, expulsion or forfeit of game(s).

Guidelines:

- 1) **Respectful Communication:** All individuals interacting with umpires are expected to communicate in a respectful, calm, and courteous manner. Disagreements may arise, but they must be expressed without resorting to loud language, personal attacks, foul language, or aggressive behavior. Judgment calls by an umpire can NEVER be questioned. Interpretations of a rule may be questioned but only in a quiet and respectful way by requesting to approach the umpire.
- 2) **Zero Physical Contact:** Any form of physical contact, whether intentional or unintentional, directed towards an umpire is strictly prohibited. This includes but is not limited to pushing, shoving, grabbing, or any aggressive physical behavior.
- 3) **Verbal Abuse:** Verbal abuse, harassment, threats, or intimidation of umpires will not be tolerated. This includes shouting, name-calling, using profanity, or making derogatory comments.
- 4) **Coaches and Players Responsibility:** Coaches and players are expected to model appropriate behavior for their team members and maintain control over their emotions. It is their responsibility to ensure that their actions do not contribute to the mistreatment of umpires. Coaches are also expected to exercise control of their players and parents. Failure to be proactive in this regard will also place coaches at disciplinary risk. RBSL knows that coaches can’t guarantee parent and

player behavior however, coaches are expected to take responsibility for proactively intervening early in situations that could put a player or parent at disciplinary risk.

- 5) Parent and Spectator Conduct: Parents and spectators are expected to support the league's values by refraining from engaging in disrespectful or aggressive behavior towards umpires. Unsportsmanlike conduct or actions that undermine the umpire's authority will not be tolerated.

Consequences:

Violations of the No Tolerance Policy will result in immediate actions, which may include, but are not limited to:

- 1) Game forfeiture: Any individual found in violation of the policy may be subject to game forfeiture without warning.
- 2) Ejection: Any individual found in violation of the policy may be ejected from the game or event without warning.
- 3) Suspension: Repeat or severe violations may lead to a suspension from further participation in RBSL games or events.
- 4) Expulsion: In extreme cases, where behavior demonstrates a consistent disregard for the policy, the individual may be expelled from participating in the league permanently.

Reporting and Investigation:

Reports of violations of this policy should be submitted in writing to the league officials. The league will conduct a fair and thorough investigation into all reported incidents. Appropriate actions will be taken based on the investigation's findings.

Appeals:

Individuals subject to consequences have the right to file a written appeal within five (5) days from the date of action. Appeals will be reviewed by a designated committee to ensure fairness.

The Rockwall Baseball and Softball League remains committed to fostering a positive and respectful environment for all participants. This No Tolerance Policy is designed to ensure that umpires are treated with the respect they deserve, allowing for the fair and enjoyable experience of all involved.

By adhering to this policy, we collectively contribute to the growth and success of our league while upholding the values of sportsmanship and fair play.



City of Rockwall
The New Horizon

Building Inspections Department Monthly Report

August 2023

Permits

Total Permits Issued:	387
Building Permits:	15
Contractor Permits:	372
Total Commercial Permit Values:	\$4,430,944.18
Building Permits:	\$48,000.00
Contractor Permits:	\$4,382,944.18
Total Fees Collected:	\$135,201.61
Building Permits:	\$35,429.57
Contractor Permits:	\$99,772.04

Board of Adjustment

Board of Adjustment Cases: 0

9/27/2023
1:20:37PM

City of Rockwall
PERMITS ISSUED - Summary by Type and Subtype
For the Period 8/1/2023 to 8/31/2023

Type/Subtype	# of Permits Issued	Valuation of Work	Fees Charged
Commercial Building Permit	75	\$4,430,944.18	\$68,916.90
Addition	1	48,000.00	\$647.75
Backflow Permit	3	15,760.72	\$327.65
Cell Tower Permit	1	3,000.00	\$96.65
Certificate of Occupancy	10		\$759.00
Demolition	4		\$202.00
Electrical Permit	9	2,250.00	\$333.99
Fence Permit	1	800.00	\$51.00
Irrigation Permit	6		\$34,754.40
Mechanical Permit	1	19,500.00	\$339.41
Plumbing Permit	8	98,895.80	\$732.17
Remodel	15	4,191,288.21	\$28,745.38
Retaining Wall Permit	2		\$102.00
Roofing Permit	1	30,479.45	\$76.50
Sign Permit	10	20,970.00	\$837.00
Temporary Certificate of Occupancy	3		\$912.00
Residential Building Permit	312		\$66,284.71
Accessory Building Permit	4		\$1,413.27
Addition	1		\$238.15
Concrete Permit	8		\$1,667.09
Deck Permit	2		\$255.00
Demolition	1		\$51.00
Driveway Permit	2		\$251.74
Electrical Permit	7		\$688.50
Fence Permit	24		\$1,289.00
Generator	2		\$303.00
Irrigation Permit	13		\$991.50
Mechanical Permit	34		\$3,873.50
New Single Family Residential	8		\$32,910.08
Outdoor Kitchen Permit	1		\$50.00
Patio Cover/Pergola	11		\$1,397.70
Plumbing Permit	39		\$3,079.50
Pool	13		\$1,968.00
Remodel	4		\$1,917.43
Retaining Wall Permit	4		\$151.00
Roofing Permit	115		\$8,697.00
Solar Panel Permit	7		\$4,312.93
Takeline - Boat House	1		\$220.32
Takeline - Seawall	1		\$51.00
Takeline - Seawall Cap	1		\$51.00
Window & Door Permit	9		\$457.00
Totals:	387		\$135,201.61

New Residential Permits

Calendar Year

	Year	
	2022	2023
January	40	11
February	18	15
March	37	20
April	32	10
May	19	20
June	20	20
July	25	23
August	23	8
September	19	
October	13	
November	10	
December	6	
Totals	262	127

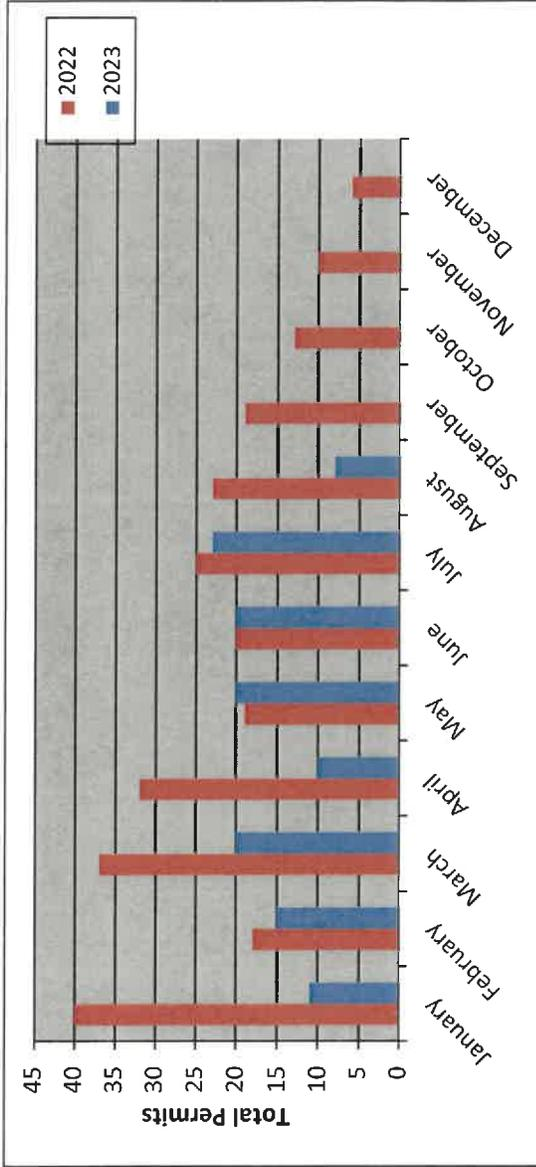

New Residential Permits

Fiscal Year

	Year	
	2021-2022	2022-2023
October	35	13
November	18	10
December	23	6
January	40	11
February	18	15
March	37	20
April	32	10
May	19	20
June	20	20
July	25	23
August	23	8
September	19	
Totals	309	156

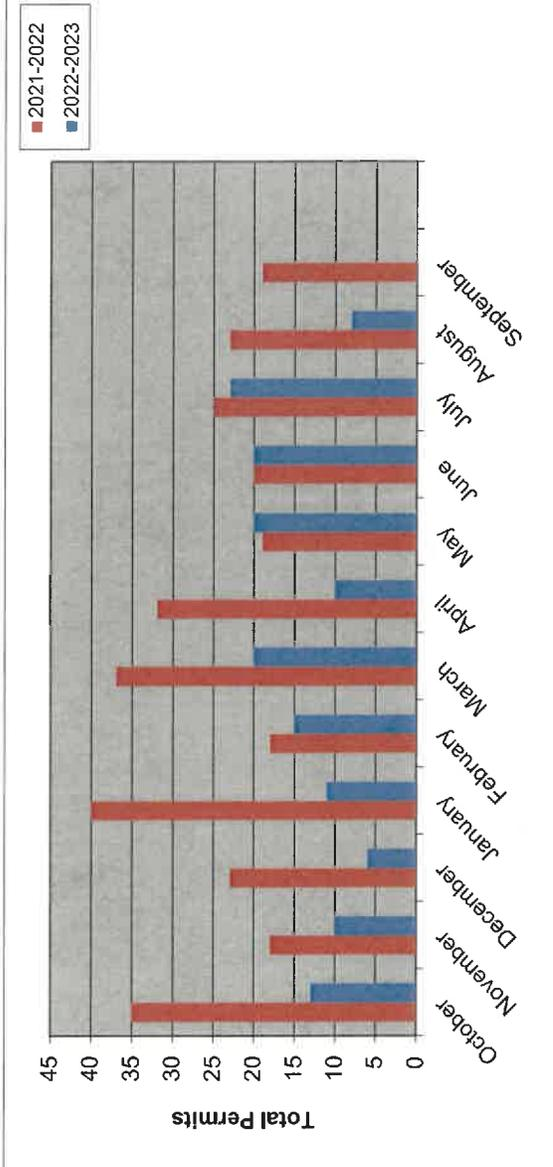

Residential Remodel Permits Calendar Year

	Year	
	2022	2023
January	3	3
February	2	1
March	2	1
April	3	0
May	2	2
June	3	2
July	4	5
August	7	14
September	4	
October	4	
November	7	
December	3	
Totals	44	28

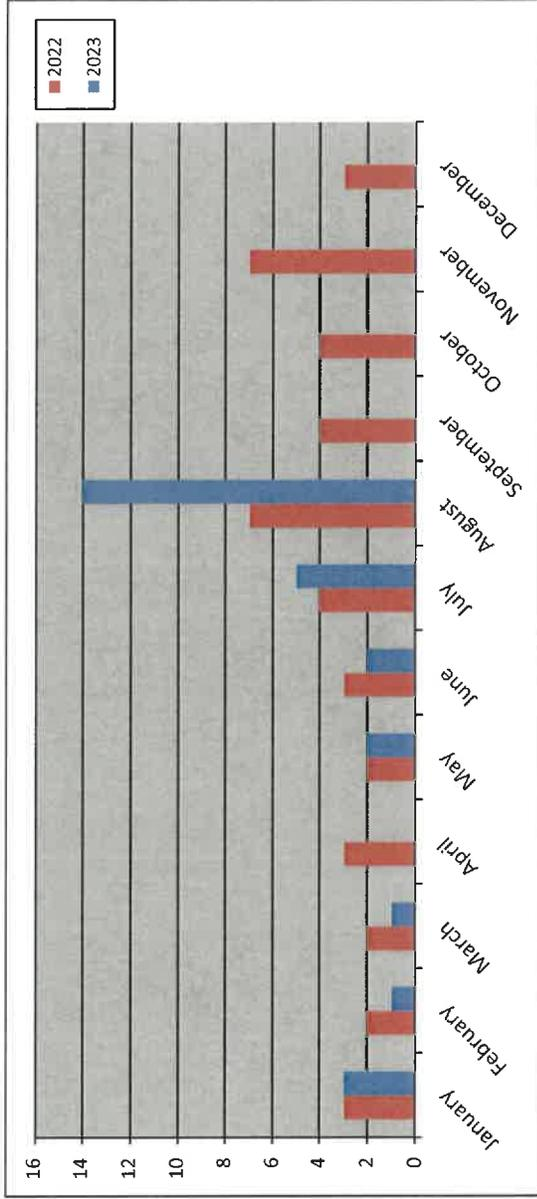

Residential Remodel Permits Fiscal Year

	Year	
	2021-2022	2022-2023
October	3	4
November	1	7
December	4	3
January	3	3
February	2	1
March	2	1
April	3	0
May	2	2
June	3	2
July	4	5
August	7	14
September	4	
Totals	38	42

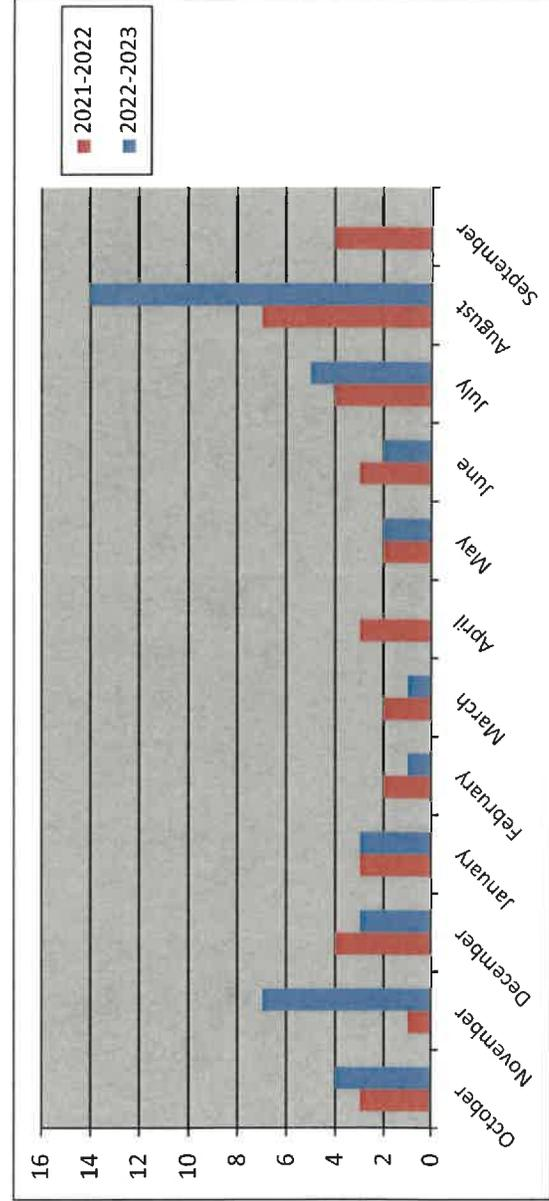

New Commercial Permits

Calendar Year

	Year	
	2022	2023
January	2	3
February	4	0
March	1	3
April	1	4
May	2	0
June	2	2
July	3	7
August	2	0
September	1	
October	3	
November	0	
December	1	
Totals	22	19

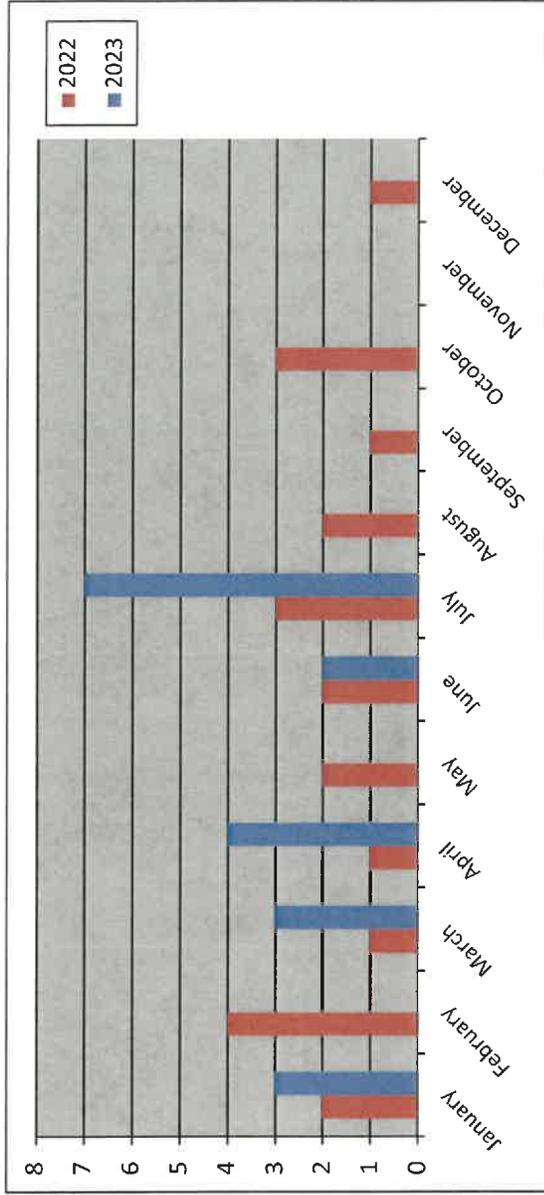

New Commercial Permits

Fiscal Year

	Year	
	2021-2022	2022-2023
October	0	3
November	1	0
December	1	1
January	2	3
February	4	0
March	1	3
April	1	4
May	2	0
June	2	2
July	3	7
August	2	0
September	1	
Totals	20	23

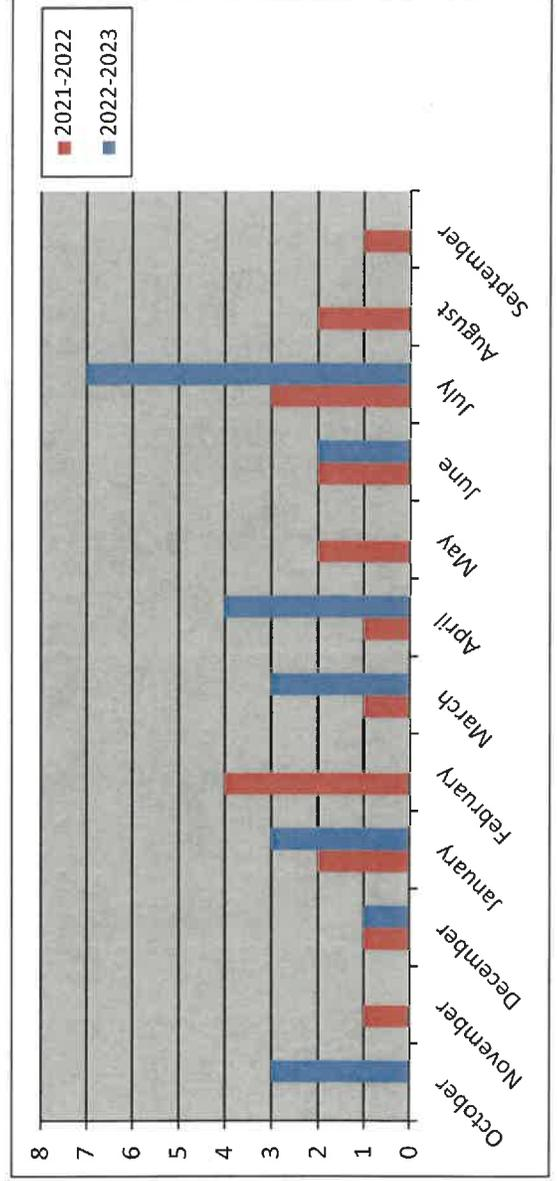

New Commercial Value

Calendar Year

	Year	
	2022	2023
January	\$ 3,625,000.00	\$ 3,684,500.00
February	\$ 4,186,300.00	\$ -
March	\$ 1,200,000.00	\$ 184,834,500.00
April	\$ 250,000.00	\$ 49,466,652.00
May	\$ 20,400,000.00	\$ -
June	\$ 6,300,000.00	\$ 8,450,000.00
July	\$ 9,075,000.00	\$ 73,254,209.00
August	\$ 6,244,700.00	\$ -
September	\$ 550,000.00	
October	\$ 7,472,450.00	
November	\$ -	
December	\$ 1,000,000.00	
Totals	\$ 60,303,450.00	\$ 319,689,861.00

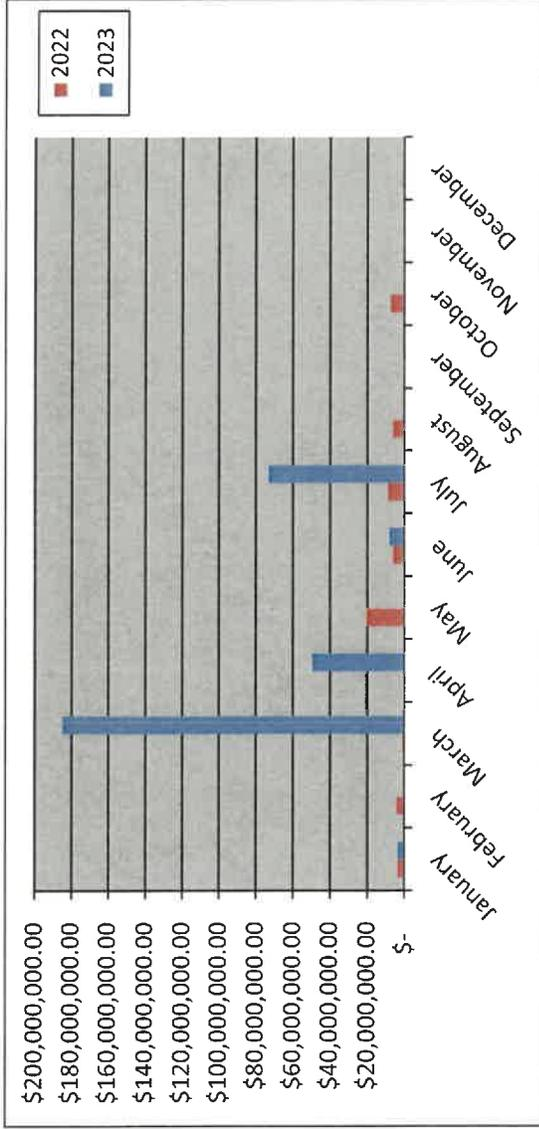

New Commercial Value

Fiscal Year

	Year	
	2021-2022	2022-2023
October	\$ -	\$ 7,472,450.00
November	\$ 750,000.00	\$ -
December	\$ 11,000,000.00	\$ 1,000,000.00
January	\$ 3,625,000.00	\$ 3,684,500.00
February	\$ 4,186,300.00	\$ -
March	\$ 1,200,000.00	\$ 184,834,500.00
April	\$ 250,000.00	\$ 49,466,652.00
May	\$ 20,400,000.00	\$ -
June	\$ 6,300,000.00	\$ 8,450,000.00
July	\$ 9,075,000.00	\$ 73,254,209.00
August	\$ 6,244,700.00	\$ -
September	\$ 550,000.00	
Totals	\$ 63,581,000.00	\$ 328,162,311.00

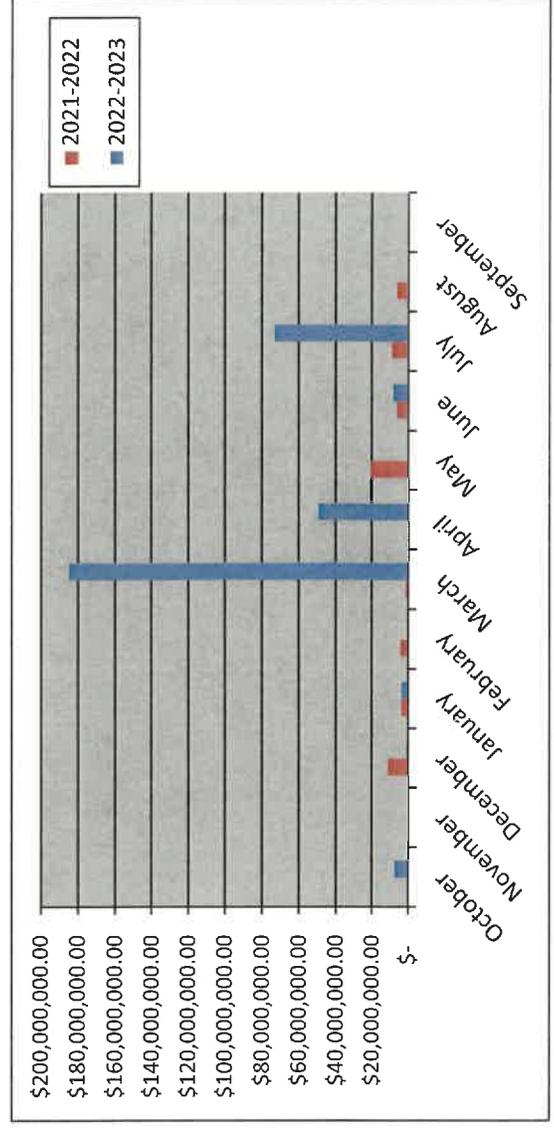

Commercial Remodel Permits Calendar Year

	Year	
	2022	2023
January	3	5
February	7	3
March	5	7
April	5	6
May	7	3
June	13	2
July	6	9
August	9	16
September	12	
October	12	
November	13	
December	5	
Totals	97	51

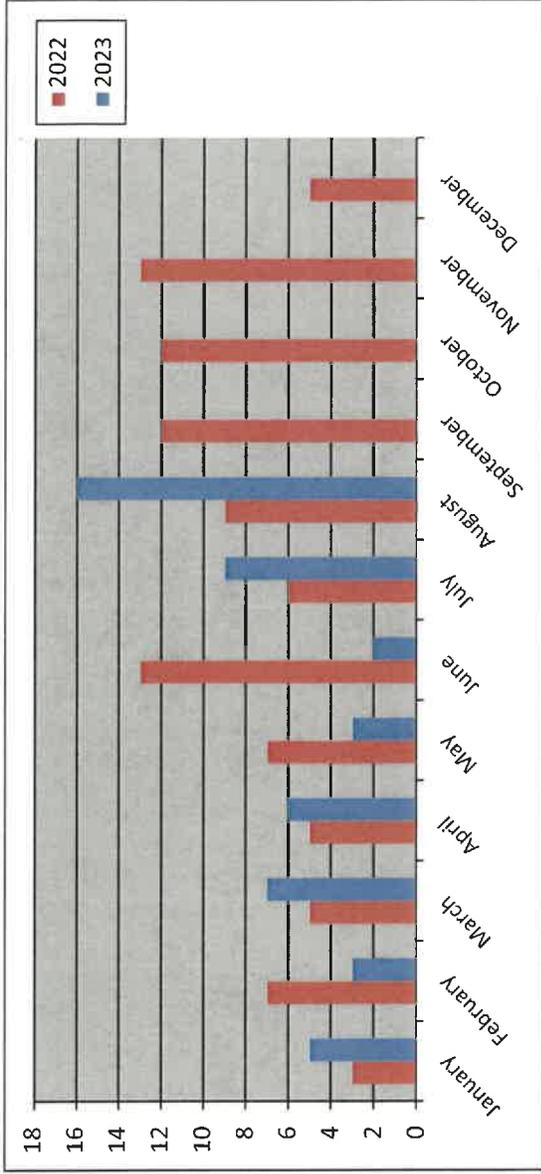

Commercial Remodel Permits Fiscal Year

	Year	
	2021-2022	2022-2023
October	6	12
November	5	13
December	8	5
January	3	5
February	7	3
March	5	7
April	5	6
May	7	3
June	13	2
July	6	9
August	9	16
September	12	
Totals	86	81

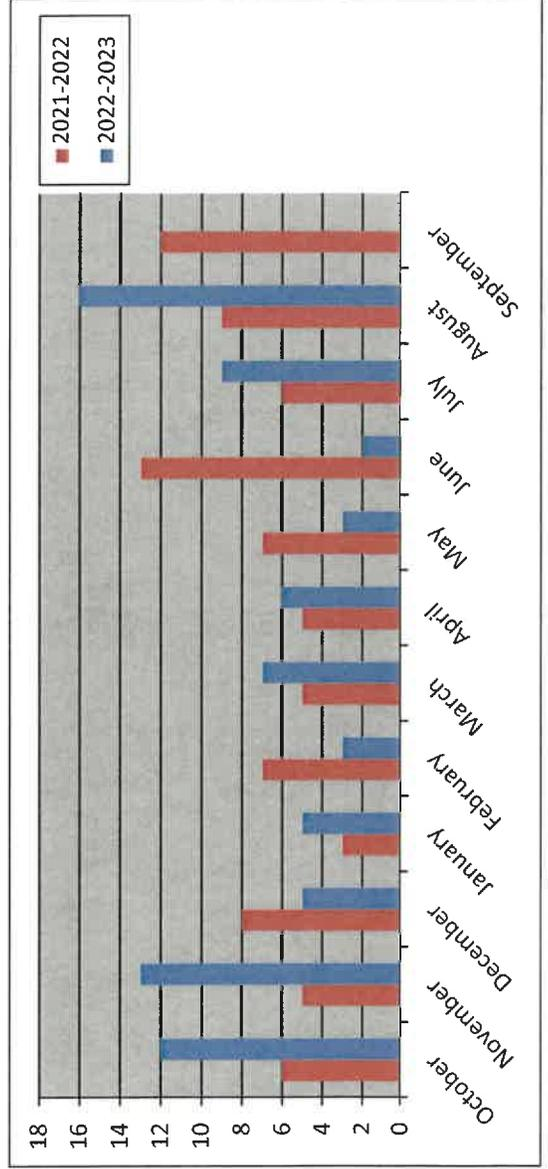

Total Fees Collected

Calendar Year

	Year	
	2022	2023
January	\$ 361,270.18	\$ 235,769.45
February	\$ 250,094.89	\$ 131,295.33
March	\$ 307,866.69	\$ 278,577.39
April	\$ 274,768.54	\$ 727,627.76
May	\$ 518,725.96	\$ 91,036.40
June	\$ 304,895.03	\$ 338,892.45
July	\$ 416,616.46	\$ 491,588.49
August	\$ 317,170.14	\$ 135,201.61
September	\$ 197,419.77	
October	\$ 274,314.07	
November	\$ 122,821.42	
December	\$ 105,480.50	
Totals	\$ 3,451,443.65	\$ 2,429,988.88

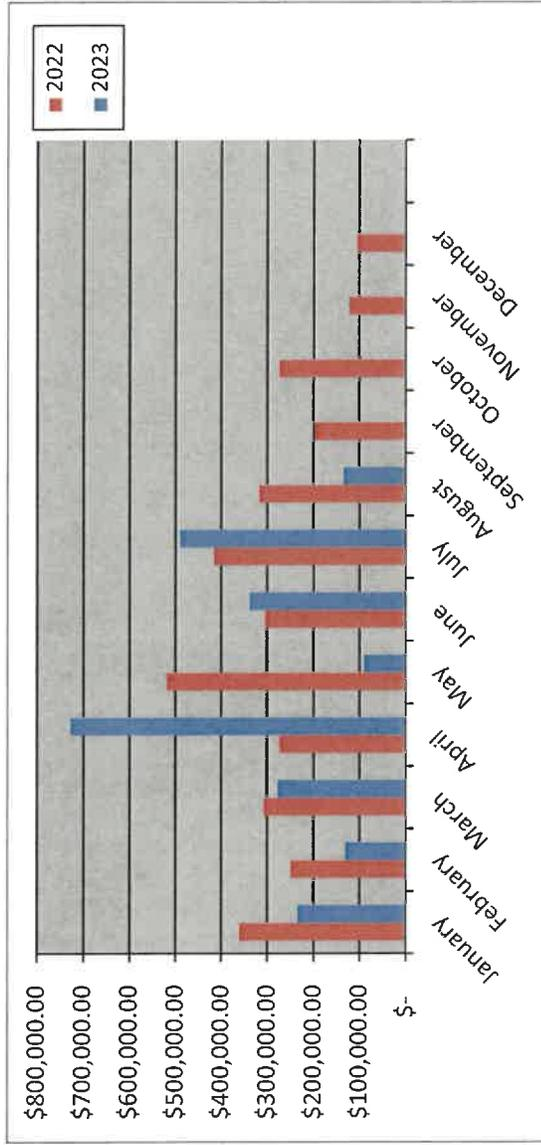

Total Fees Collected

Fiscal Year

	Year	
	2021-2022	2022-2023
October	\$ 273,670.22	\$ 274,314.07
November	\$ 163,206.06	\$ 122,821.42
December	\$ 310,002.73	\$ 105,480.50
January	\$ 361,270.18	\$ 235,769.45
February	\$ 250,094.89	\$ 131,295.33
March	\$ 307,866.69	\$ 278,577.39
April	\$ 274,768.54	\$ 727,627.76
May	\$ 518,725.96	\$ 91,036.40
June	\$ 304,895.03	\$ 338,892.45
July	\$ 416,616.46	\$ 491,588.49
August	\$ 317,170.14	\$ 135,201.61
September	\$ 197,419.77	
Totals	\$ 3,695,706.67	\$ 2,932,604.87

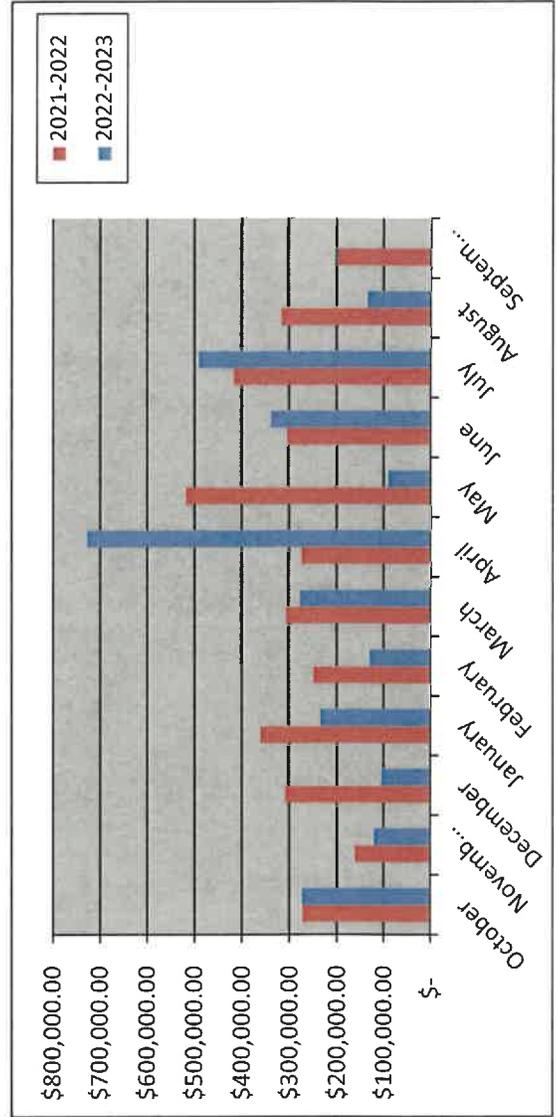

1:22:54PM

CERTIFICATES OF OCCUPANCY ISSUED

For the Period 8/1/2023 to 8/31/2023

Permit Number	Permit Type	Site Address	Total Fees
Application Date	Subtype	Parcel Number	
Issue Date	Status of Permit	Subdivision Name	
	Business Name	Plan Number	Valuation
			Total SQFT
			Fees Paid
COM2022-3675	Commercial Building Permit		
06/15/2022	Certificate of Occupancy	1035 E INTERSTATE 30,	\$75.00
08/10/2023	ISSUED	105, ROCKWALL, TX,	2,836.00
	FIVE GUYS BURGERS & FRIES	75032	

Contact Type	Contact Name	Contact Address			
	Business Phone				
Business Owner	FIVE GUYS PROPERTIES 845-285-0990	1035 E 1-30 STE 105	Rockwall	TX	75087
Property Owner	EXCEL ROCKWALL, LLC				

Contractors

COM2023-2081	Commercial Building Permit		
05/08/2023	Certificate of Occupancy	1901 GOLIAD ST S, #1,	\$76.50
08/18/2023	ISSUED	ROCKWALL, TX 75087	650.00
	Exclusive Sneaks Shop		

Contact Type	Contact Name	Contact Address			
	Business Phone				
Business Owner	Daunte Crawford 214-914-6704	1901 S Goliad St, Suite 1	Rockwall	TX	75087
Property Owner	DONNA CULLINS PRITCHARD	1610 SHORES BLVD	ROCKWALL	TX	75087

Contractors

COM2023-2658	Commercial Building Permit		
06/07/2023	Certificate of Occupancy	5739 HORIZON RD,	\$76.50
08/23/2023	ISSUED	ROCKWALL, TX 75032	1,070.00
	Endo Dispensary & Wellness		

Contact Type	Contact Name	Contact Address			
	Business Phone				
Business Owner	Jaime A Rodriguez 214-878-9917	369 Red Cedar Dr	Rockwall	TX	75087
Property Owner	Ridge Pointe	102 S Goliad St	Rockwall	TX	75087
Inspection Report C	Jaime A Rodriguez				

Contractors

COM2023-2690	Commercial Building Permit		
06/09/2023	Certificate of Occupancy	5651 STATE HIGHWAY	\$76.50
08/24/2023	ISSUED	276, ROCKWALL,	23,500.00
	Rockwall Friendship Baptist Church	75189	

1:22:54PM

CERTIFICATES OF OCCUPANCY ISSUED

For the Period 8/1/2023 to 8/31/2023

Permit Number	Permit Type	Site Address				Total Fees
Application Date	Subtype	Parcel Number				
Issue Date	Status of Permit	Subdivision Name				
	Business Name	Plan Number	Valuation	Total SQFT	Fees Paid	
Contact Type	Contact Name	Contact Address				
	Business Phone					
Business Owner	Shanon Thomas	5651 SH 276	Royse City	TX	75189	
Property Owner	Shanon Thomas	5651 SH 276	Royse City	TX	75189	

Contractors

COM2023-3143	Commercial Building Permit					
07/06/2023	Certificate of Occupancy	909 N GOLIAD ST,				\$76.50
08/01/2023	ISSUED	ROCKWALL, TX 75087				1,100.00
	ReVive Aesthetics & Healthcare					

Contact Type	Contact Name	Contact Address				
	Business Phone					
Business Owner	Windy Busher 214-305-6423	907 N Goliad St	Rockwall	TX	75087	
Property Owner	Double T Ventures	1500 S. Kreymer Ln.	Wylie	TX	75098	
Inspection Report C	Windy Busher	907 N. Goliad St.	Rockwall	TX	75087	

Contractors

COM2023-3253	Commercial Building Permit					
07/11/2023	Certificate of Occupancy	1400 E INTERSTATE 30,				\$75.00
08/09/2023	ISSUED	ROCKWALL ,TX 75087				4,200.00
	Pro Source LED					

Contact Type	Contact Name	Contact Address				
	Business Phone					
Business Owner	Amanda Cicio 214-799-6904	1400 E Interstate 30	Rockwall	TX	75087	
Property Owner	M&D Real Estate	2500 Discovery Ste 200	Rockwall	TX	75032	

Contractors

COM2023-3589	Commercial Building Permit					
07/27/2023	Temporary Certificate of Occupancy	2350 DISCOVERY BLVD,				\$306.00
08/02/2023	ISSUED	ROCKWALL, TX 75087				39,940.00
	The Royalton at Discovery (Bldg 9 - C - 34 Units)					

1:22:54PM

CERTIFICATES OF OCCUPANCY ISSUED

For the Period 8/1/2023 to 8/31/2023

Permit Number	Permit Type	Site Address		Total Fees	
Application Date	Subtype	Parcel Number			
Issue Date	Status of Permit	Subdivision Name			
	Business Name	Plan Number	Valuation	Total SQFT	Fees Paid
Contact Type	Contact Name Business Phone	Contact Address			
Business Owner	SWBC RW2, LP 469-889-1661	5949 SHERRY LN, SUITE 750	Dallas	TX 75225	
Property Owner	Spencer Byington	5949 Sherry Ln	Dallas	TX 75225	
Applicant	FB WHITELEY				
Contractors					

COM2023-3706	Commercial Building Permit				
08/02/2023	Certificate of Occupancy	445 E INTERSTATE 30,		\$75.00	\$75.00
08/31/2023	ISSUED	ROCKWALL, 75087		2,400.00	
	Adios Fajitas				

Contact Type	Contact Name Business Phone	Contact Address			
Business Owner	Richard Torres 832-451-0421	248 Summer Tanager Ln	Rockwall	TX 75032	
Property Owner	Sabre Realty Management	16475 Dallas Pkwy	Addison	TX 75001	

Inspection Report (Nick Gambill

Contractors

COM2023-3728	Commercial Building Permit				
08/03/2023	Temporary Certificate of Occupancy	1901 STATE HIGHWAY		\$306.00	\$306.00
08/08/2023	ISSUED	276, ROCKWALL,		21,318.00	
	IDP	75032			

Contact Type	Contact Name Business Phone	Contact Address			
Business Owner	Brandon Buschold 805-304-5869	1901 State Highway 276	Rockwall	TX 75032	
Property Owner	Brandon Buschold	1901 State Highway 276	Rockwall	TX 75032	

Contractors

COM2023-3885	Commercial Building Permit				
08/14/2023	Temporary Certificate of Occupancy	703 N GOLIAD ST,		\$300.00	\$300.00
08/17/2023	ISSUED	ROCKWALL, TX 75087		1,840.00	
	Right at Home				

1:22:54PM

CERTIFICATES OF OCCUPANCY ISSUED

For the Period 8/1/2023 to 8/31/2023

Permit Number	Permit Type	Site Address	Valuation	Total Fees	Fees Paid
Application Date	Subtype	Parcel Number			
Issue Date	Status of Permit	Subdivision Name		Total SQFT	
Contact Type	Contact Name	Contact Address			
	Business Name	Plan Number			
	Business Phone				
Business Owner	Mark Reynolds	703 N Goliad St	Rockwall	TX	75087
	469-314-1774				
Property Owner	Mark Reynolds	12017 Kilgore Dr	Frisco	TX	75035
Applicant	Rachel K Reynolds				

Contractors

COM2023-4048	Commercial Building Permit				
08/21/2023	Certificate of Occupancy	216 RANCH TRL			\$75.00 \$75.00
08/28/2023	ISSUED				4,800.00
	1800 Dalrock LLC				

Contact Type	Contact Name	Contact Address			
	Business Phone				
Business Owner	Mark Andrews	2424 Ridge Rd	Rockwall	TX	75087
	469-298-1594				
Property Owner	Mark Andrews	2424 Ridge Rd	Rockwall	TX	75087
Inspection Report C	Kevin J Lloyd				

Contractors

COM2023-4136	Commercial Building Permit				
08/24/2023	Certificate of Occupancy	811 E YELLOW JACKET			\$76.50 \$76.50
08/29/2023	ISSUED	LN Suite 122			700.00
	Black Lotus CBD & Vape				

Contact Type	Contact Name	Contact Address			
	Business Phone				
Business Owner	Cole Wengender	718 Roaming Road Dr	Allen	TX	75002
	214-728-9582				
Property Owner	David Lowrey	2070 Pontchartrain	Rockwall	TX	75087
Inspection Report C	Cole Wengender				

Contractors

COM2023-528	Commercial Building Permit				
02/08/2023	Certificate of Occupancy	2754 STATE HIGHWAY			\$76.50 \$76.50
08/21/2023	ISSUED	276, 300, ROCKWALL,			947.00
	Cynthia's Lux Pet Salon	TX, 75032			

CERTIFICATES OF OCCUPANCY ISSUED

For the Period 8/1/2023 to 8/31/2023

Permit Number	Permit Type	Site Address			
Application Date	Subtype	Parcel Number		Total Fees	
Issue Date	Status of Permit	Subdivision Name			
	Business Name	Plan Number	Valuation	Total SQFT	Fees Paid
Contact Type	Contact Name	Contact Address			
	Business Phone				
Business Owner	Cynthia Barenos 469-360-3019	1924 Evergreen Dr	Rockwall	TX 75032	
Property Owner	Lynstar LLC	PO Box 847	Rockwall	TX 75087	

Contractors

13

Total Valuation:
Total Fees: \$1,671.00
Total Fees Paid: \$1,671.00



August 2023
Monthly Report

Top 10 NFIRS Call Types

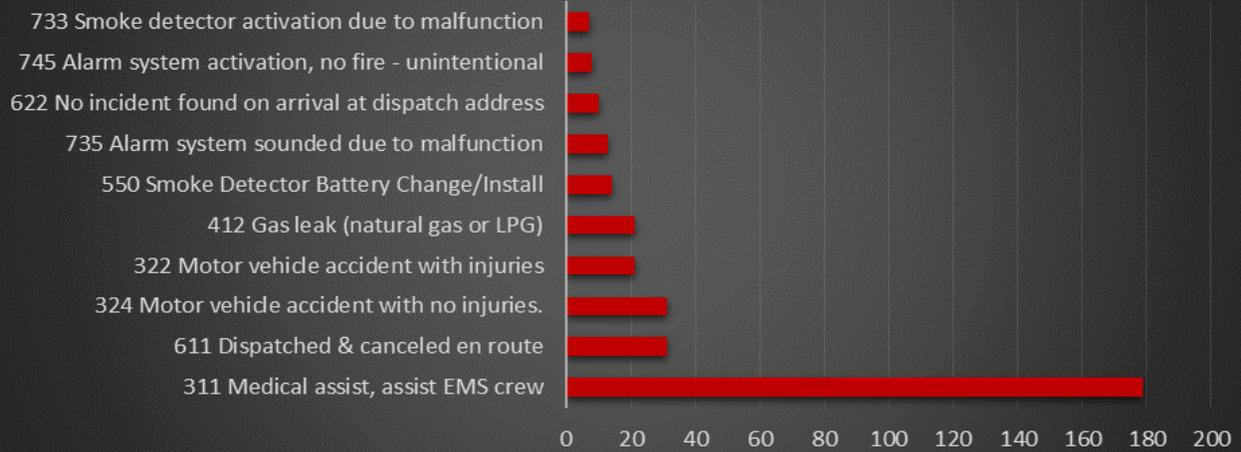

All Calls By NFIRS Call Type	Incident Count
111 Building fire	4
113 Cooking fire, confined to container	1
118 Trash or rubbish fire, contained	1
122 Fire in motor home, camper, recreational vehicle	1
132 Road freight or transport vehicle fire (Commercial Vehicles)	1
143 Grass fire	2
151 Outside rubbish, trash or waste fire	1
161 Outside storage fire	1
300 Rescue, EMS incident, other	1
311 Medical assist, assist EMS crew	179
322 Motor vehicle accident with injuries	21
324 Motor vehicle accident with no injuries.	31
340 Search for lost person, other	1
353 Removal of victim(s) from stalled elevator	1
412 Gas leak (natural gas or LPG)	21
413 Oil or other combustible liquid spill	2
441 Heat from short circuit (wiring), defective/worn	2
444 Power line down	3
511 Lock-out	4
521 Water evacuation	1
522 Water or steam leak	2
550 Public service assistance, other	2
550 Smoke Detector Battery Change/Install	14
551 Assist police or other governmental agency	1
553 Public service	3
554 Assist invalid	1
555 Defective elevator, no occupants	2
611 Dispatched & canceled en route	31
622 No incident found on arrival at dispatch address	10
651 Smoke scare, odor of smoke	5
653 Smoke from barbecue, tar kettle	1
671 HazMat release investigation w/no HazMat	1
700 False alarm or false call, other	2
715 Local alarm system, malicious false alarm	1
730 System malfunction, other	5
731 Sprinkler activation due to malfunction	1
733 Smoke detector activation due to malfunction	7
734 Heat detector activation due to malfunction	1
735 Alarm system sounded due to malfunction	13
736 CO detector activation due to malfunction	2
743 Smoke detector activation, no fire - unintentional	7
745 Alarm system activation, no fire - unintentional	8
746 Carbon monoxide detector activation, no CO	2
911 Citizen complaint	1
Grand Total	402

August 2023 Dispatch to Arrival Analysis

District	Total Number of Calls	Percent of Runs per District	Number of Calls in 5.5 mins or Less	Average FD Response Time Minutes	% in 5.5 min or less	Goal of 90%
District 1	94	29%	78	0:04:57	83%	90%
District 2	88	28%	72	0:04:52	82%	90%
District 3	37	12%	28	0:04:47	76%	90%
District 4	54	17%	43	0:04:30	80%	90%
District 5	20	6%	4	0:06:52	20%	90%
District 6	4	1%	1	0:06:30	25%	90%
District 7	19	6%	4	0:07:24	21%	90%
District 8	4	1%	3	0:04:59	75%	90%
District 9	0	0%	0	0:00:00	No Calls	90%
Department	320	100%	233	0:05:07	73%	90%

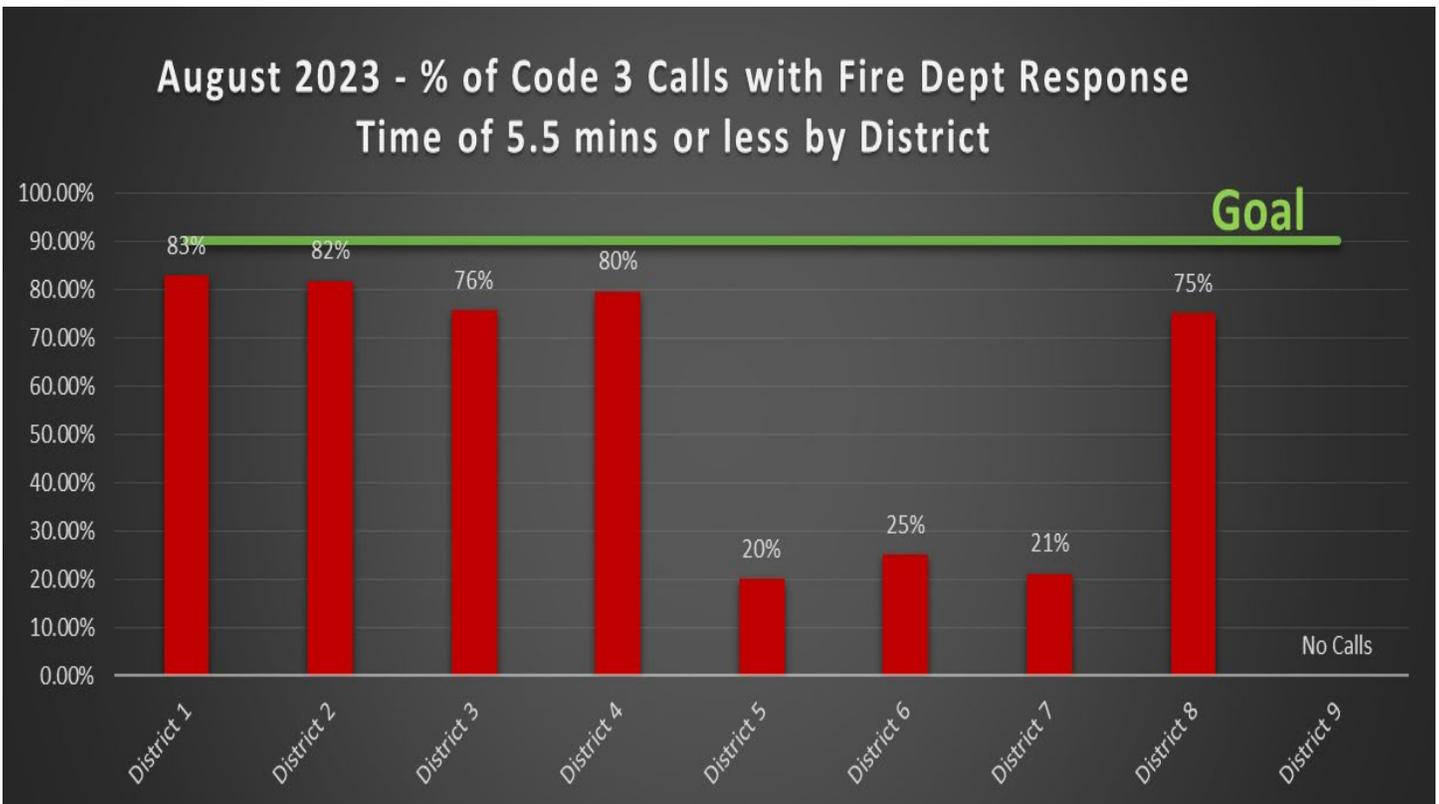

August 2023 Travel Times by District

District	Total Number of Calls	Percent of Runs per District	Number of Calls in 4 or Less	Average Travel Time Minutes	% in 4 min or less	Goal of 90%
District 1	94	29%	70	0:04:00	74%	90%
District 2	88	28%	71	0:03:48	81%	90%
District 3	37	12%	26	0:03:58	70%	90%
District 4	54	17%	39	0:03:34	72%	90%
District 5	20	6%	2	0:05:52	10%	90%
District 6	4	1%	0	0:05:39	0%	90%
District 7	19	6%	4	0:05:08	21%	90%
District 8	4	1%	2	0:04:30	50%	90%
District 9	0	0%	0	0:00:00	No Calls	90%
Department	320	100%	214	0:04:05	67%	90%

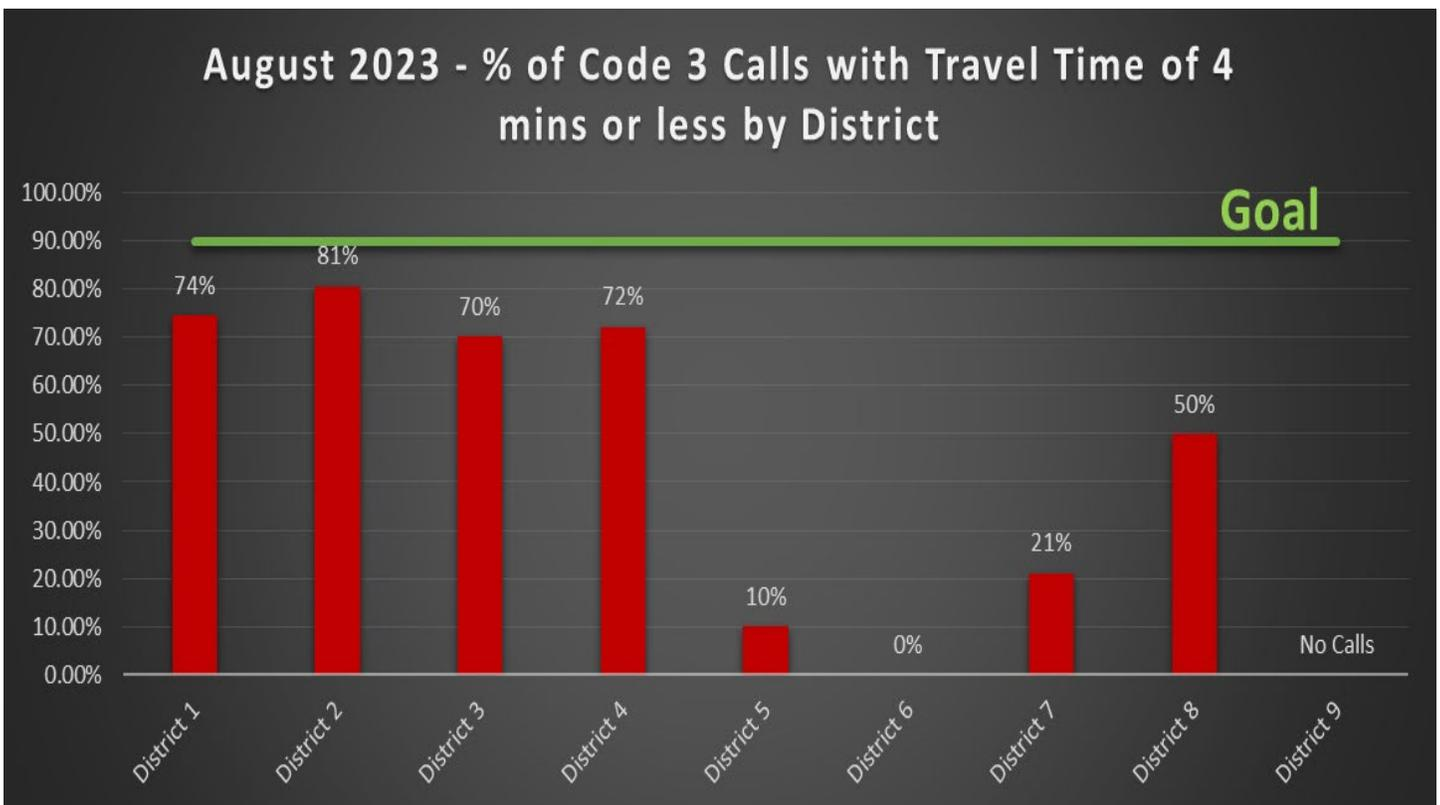



Total Dollar Losses

August 2023



City of Rockwall
The New Horizon

Rockwall Fire Department

Print Date/Time: 09/12/2023 10:42
Login ID: rck\ldgang
Layer: All
Areas: All

ORI Number: TX504
Incident Type: All
Station: All

	Current Month	Last Month	Same Month Last Year	Year To Date	Last Year To Date
Total Property Loss:	\$50,000.00	\$592,320.32	\$7,000.00	\$1,637,750.32	\$968,720.00
Total Content Loss:	\$50,000.00	\$284,073.75	\$0.00	\$2,049,173.75	\$870,000.00
Total Property Pre-Incident Value:	\$288,320.00	\$1,054,132.32	\$69,750.00	\$117,249,418.32	\$60,984,610.00
Total Contents Pre-Incident Value	\$100,000.00	\$405,092.19	\$6,975.00	\$24,728,920.19	\$21,796,975.00
Total Losses:	\$100,000.00	\$876,394.07	\$7,000.00	\$3,686,924.07	\$100,000.00
Total Value:	\$388,320.00	\$1,459,224.51	\$76,725.00	\$141,978,338.51	\$82,781,585.00

Fire Prevention, Education, & Investigations Division Monthly Report August 2023

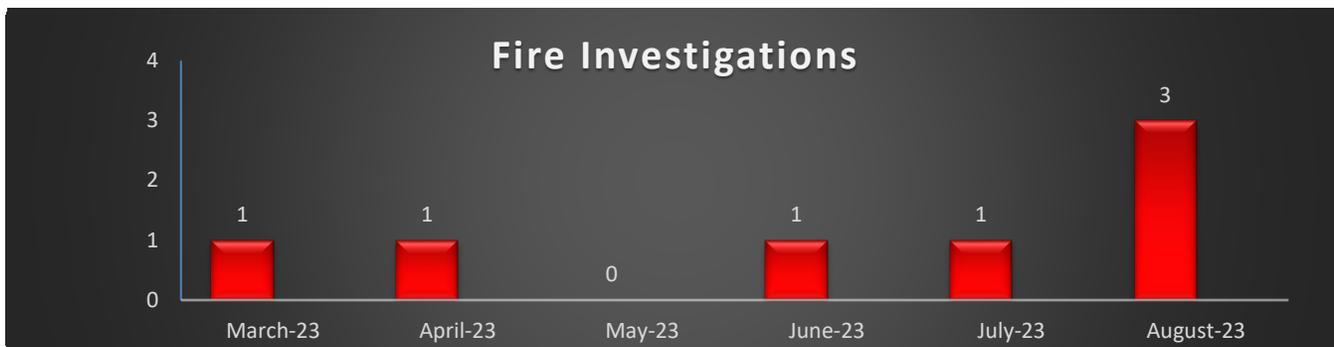
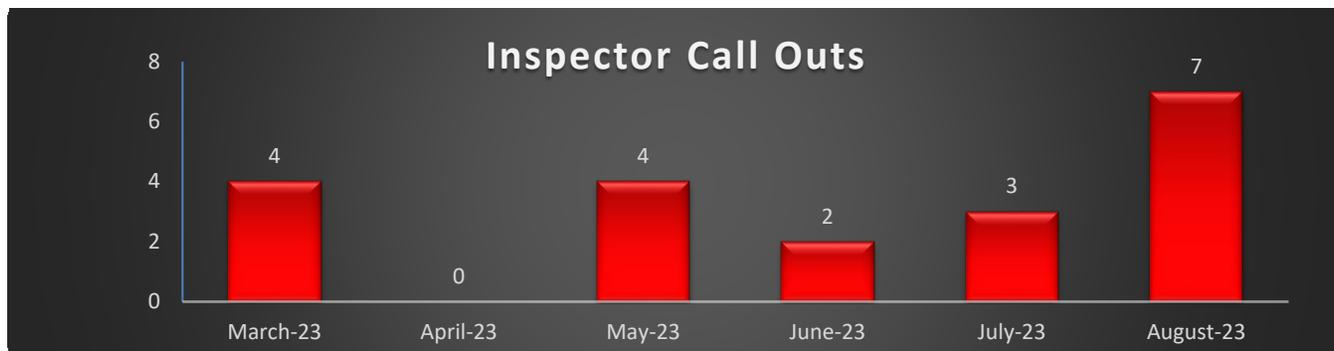
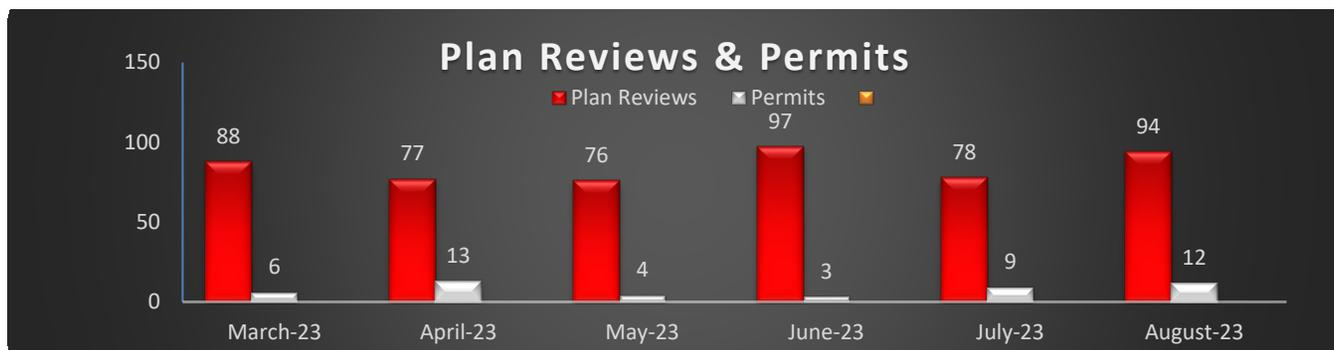
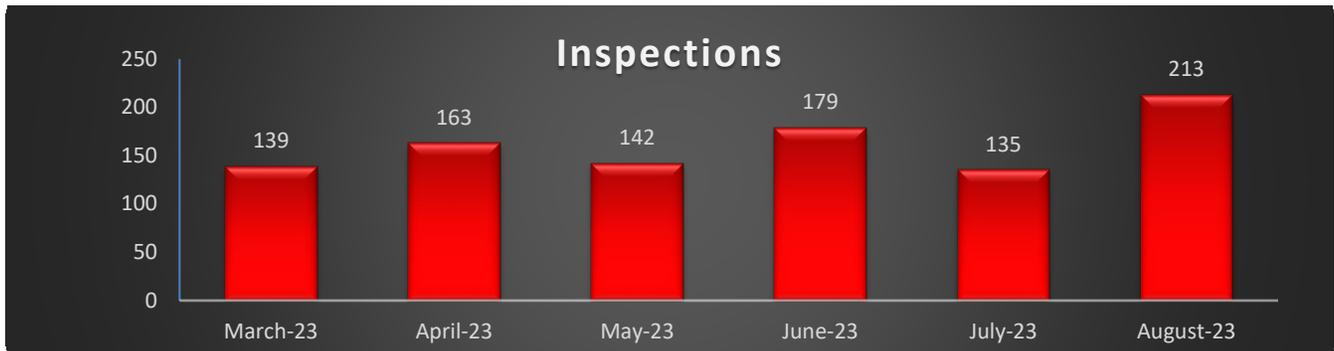



Monthly Report August 2023

SENIOR TRIP TO MOVIES
8 ATTENDEES

SENIOR LUNCHEON
70 ATTENDEES

RBSL FALL SEASON START
1022 PLAYERS



REVENUE NUMBERS

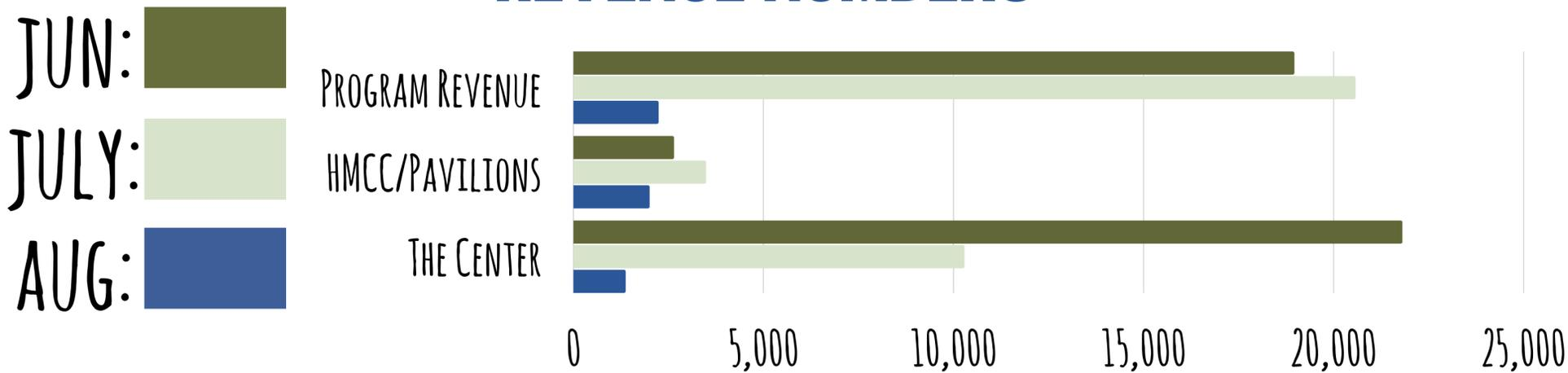

Upcoming:

Rib Rub Run & Roll	October 7, 2023
Harmony at The Harbor	Begins October 12, 2023
Halloween at The Harbor	October 28, 2023

PARKS PROJECT UPDATE – AUGUST 2023



PARKS BUILDING PAINTING
PARKING



DISC GOLF FLAG REPAIR

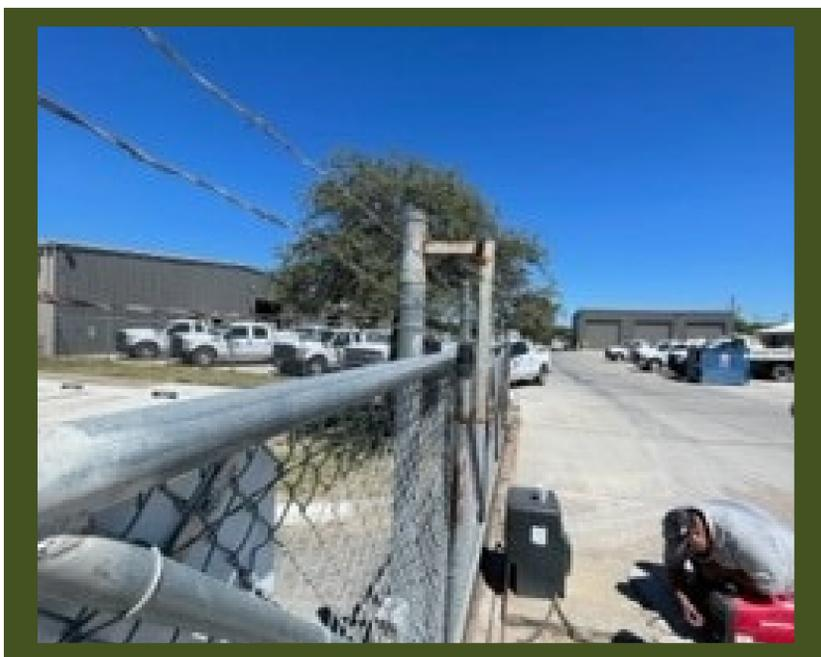

SHOP GATE REPAIR



THE HARBOR PARKING DIRT CLEAN UP

Other Projects

SOCKET AND DRAIN REPAIR AT TUTTLE CONCESSIONS

CARUTH CLEAN UP

Rockwall Police Department

Monthly Activity Report

August-2023

ACTIVITY	CURRENT MONTH AUGUST	PREVIOUS MONTH JULY	YTD 2023	YTD 2022	YTD % CHANGE
----------	-------------------------	------------------------	-------------	-------------	-----------------

PART 1 OFFENSES

Homicide / Manslaughter	0	0	0	0	0.00%
Sexual Assault	2	0	8	10	-20.00%
Robbery	0	1	8	9	-11.11%
Aggravated Assault	3	4	19	22	-13.64%
Burglary	2	4	27	25	8.00%
Larceny	54	32	395	459	-13.94%
Motor Vehicle Theft	10	6	58	36	61.11%
TOTAL PART I	71	47	515	561	-8.20%
TOTAL PART II	118	120	966	1030	-6.21%
TOTAL OFFENSES	189	167	1481	1591	-6.91%

ADDITIONAL STATISTICS

FAMILY VIOLENCE	10	9	79	62	27.42%
D.W.I.	15	13	103	124	-16.94%

ARRESTS

FELONY	17	35	204	195	4.62%
MISDEMEANOR	59	49	408	445	-8.31%
WARRANT ARREST	7	8	59	58	1.72%
JUVENILE	7	2	41	59	-30.51%
TOTAL ARRESTS	90	94	712	757	-5.94%

DISPATCH

CALLS FOR SERVICE	2325	2569	20088	15830	26.90%
-------------------	------	------	-------	-------	--------

ACCIDENTS

INJURY	0	1	10	31	-67.74%
NON-INJURY	118	94	724	585	23.76%
FATALITY	0	0	1	2	-50.00%
TOTAL	118	95	735	618	18.93%

FALSE ALARMS

RESIDENT ALARMS	48	62	382	357	7.00%
BUSINESS ALARMS	174	150	1176	1261	-6.74%
TOTAL FALSE ALARMS	222	212	1558	1618	-3.71%
Estimated Lost Hours	146.52	139.92	1028.28	1067.88	-3.71%
Estimated Cost	\$3,485.40	\$3,328.40	\$24,460.60	\$25,402.60	-3.71%

ROCKWALL NARCOTICS UNIT

Number of Cases	2
Arrests	3
Arrest Warrants	0
Search Warrants	2
Seized	
Marijuana	2 oz
THC Oil	39 grams
Weapons	2
Money	\$19,000

Sales Tax Collections - Rolling 36 Months

	<u>General Fund</u>	<u>TIF</u>
	<u>Sales Tax</u>	<u>Sales Tax</u>
Aug-20	1,979,539	17,706
Sep-20	1,573,352	12,179
Oct-20	1,558,570	14,888
Nov-20	1,989,955	15,299
Dec-20	1,634,280	14,994
Jan-21	1,718,364	13,341
Feb-21	2,244,778	14,935
Mar-21	1,521,031	12,738
Apr-21	1,952,165	10,954
May-21	2,651,412	18,252
Jun-21	2,080,645	27,773
Jul-21	1,877,982	22,940
Aug-21	1,930,521	24,860
Sep-21	1,882,276	27,803
Oct-21	1,860,016	19,744
Nov-21	2,317,862	21,385
Dec-21	1,963,345	23,464
Jan-22	2,040,002	20,495
Feb-22	2,664,185	23,976
Mar-22	1,786,902	21,605
Apr-22	1,633,850	17,548
May-22	2,559,349	26,254
Jun-22	2,050,066	25,127
Jul-22	2,135,457	29,738
Aug-22	2,381,510	34,190
Sep-22	2,092,217	36,105
Oct-22	2,177,040	25,420
Nov-22	2,291,130	17,990
Dec-22	2,068,593	21,213
Jan-23	2,231,654	21,134
Feb-23	2,792,696	24,982
Mar-23	1,949,994	20,438
Apr-23	1,938,490	24,487
May-23	2,631,033	26,766
Jun-23	1,859,485	29,862
Jul-23	2,169,495	30,350
Aug-23	2,517,879	34,558

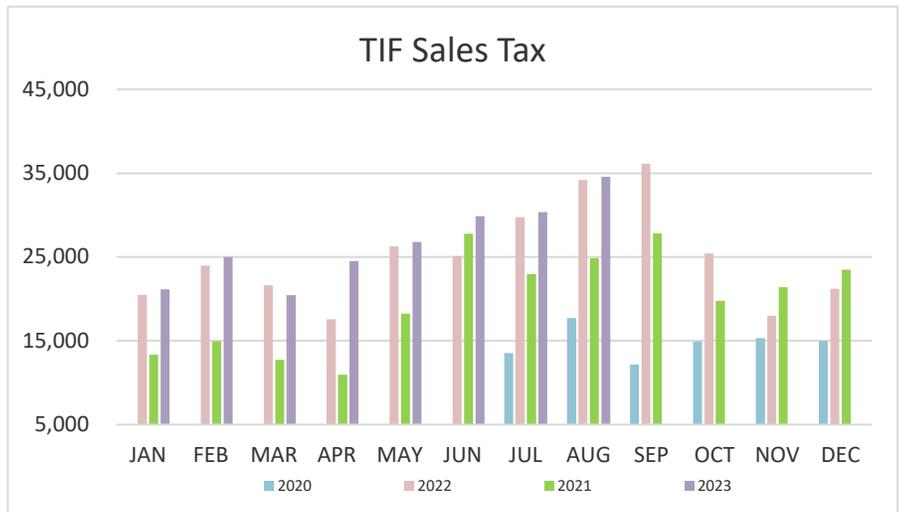
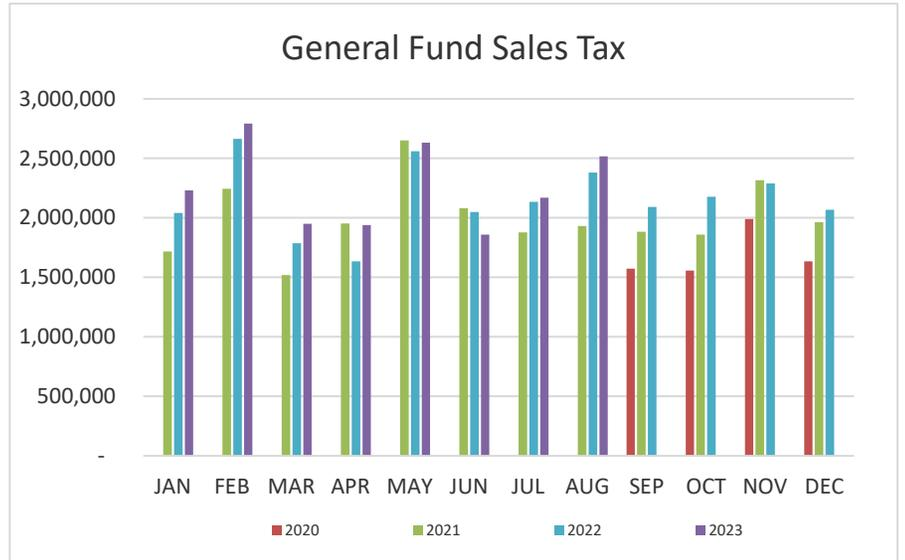

Notes:
75% of total sales tax collected is deposited to the General Fund each month
Comptroller tracks sales tax generated in the TIF and reports it monthly
75% of TIF sales tax (city share) is pledged to the TIF

Monthly Water Consumption - Rolling 27 Months

	<u>Total Gallons</u>	<u>Daily Average</u>	<u>Maximum Day</u>
Jun-21	342,904,230	11,430,141	16,988,604
Jul-21	446,687,809	14,409,284	17,918,524
Aug-21	486,443,590	15,691,730	18,928,160
Sep-21	377,898,464	17,173,544	19,016,086
Oct-21	293,280,384	11,880,576	15,338,545
Nov-21	280,398,508	9,346,618	12,584,820
Dec-21	262,730,021	8,475,163	10,313,293
Jan-22	245,557,172	7,921,199	10,742,941
Feb-22	211,955,941	7,569,855	10,394,759
Mar-22	256,035,618	8,529,214	10,544,988
Apr-22	281,707,217	9,390,241	11,718,730
May-22	356,050,664	11,485,506	15,634,756
Jun-22	496,374,560	16,545,820	21,414,344
Jul-22	679,705,160	21,925,974	24,474,168
Aug-22	534,145,350	17,230,494	23,206,750
Sep-22	434,247,536	14,474,915	17,617,728
Oct-22	421,229,833	13,588,058	17,692,206
Nov-22	228,795,657	7,626,522	11,187,251
Dec-22	249,341,535	8,043,275	12,260,392
Jan-23	243,528,725	7,855,765	11,040,666
Feb-23	198,103,255	7,075,116	8,544,708
Mar-23	220,326,930	7,107,320	10,825,669
Apr-23	292,874,560	9,762,486	13,280,734
May-23	355,482,851	11,467,189	16,032,988
Jun-23	491,086,630	16,369,555	21,693,510
Jul-23	587,439,800	18,949,672	23,599,534
Aug-23	742,795,770	23,961,154	25,727,492

Source: SCADA Monthly Reports generated at the Water Pump Stations

